



# Mining Solutions

*Efficient irrigation for leach recovery of gold, silver and copper that conserves energy and helps reduce carbon footprint.*



# WHAT'S INSIDE

## WOBBLER® SPRINKLERS

■ mini-Wobbler™	04
■ Xcel-Wobbler™	06
■ Wobbler®	08
■ Installation Options	10

## ADVANTAGES OF WOBBLER® TECHNOLOGY

■ Uniformity	11
■ Orifice	12
■ Cost Savings	12
■ Side Slope Leaching	13

## AUTOMATION SOLUTIONS

■ Sennode Bt Controller, Electric Valves	
■ Other Solutions	14

## IMPACT SPRINKLERS

■ Impact Sprinkler: Part Circle	16
■ Dust Suppression	18
■ Impact Sprinkler: 80 Series	20

## SPRAYS

■ Super Spray® for Evaporation	22
--------------------------------	----

## PRESSURE REGULATION

■ Pressure Regulation Overview	24
■ PRMP - Mining Prospector	26
■ PRL - Low Flow	28
■ PMR-MF - Medium Flow	30
■ PR-HF - High Flow	32
■ PRU - Ultra Flow	34
■ PRLV - Limit Valve	36
■ PRXF-LV - Extended Flow	
■ Limit Valve	38

## COMPONENTS

■ Riser Adapter	40
■ Quick-Connect Coupling	41

## SOFTWARE

■ WinSIPP™3 Mining	42
■ Irri-Maker™	44

## RESOURCES

■ Nozzles	46
■ Warranty	47

# MINING SOLUTIONS

In 1970, Senninger Irrigation developed the **Custom Mining Sprinkler (CMS)** line, which offers sprinkler technology solutions for the mining industry.



is the company motto for developing efficient irrigation that conserves energy and provides exceptional uniformity for pad leaching while helping the carbon footprint.

## Precision Irrigation Sprinkler Advantages

All Senninger Custom Mining Sprinklers (CMS) are constructed with the highest engineering-grade thermoplastic resins to resist corrosion, abrasion, ultraviolet degradation, and chemical degradation due to the use of sulfuric acid, cyanide, and more.

They are built for stronger and more durable performance associated with gold, silver, and copper mining applications.



# mini-Wobbler™

Flow: 0.42 to 2.18 gpm (95 to 495 L/hr)  
 Pressure: 15 to 25 psi (1.03 to 1.72 bar)



## FEATURES

- Outstanding uniformity
- High application efficiency at low operating pressures
- Various droplet sizes available based on selected nozzle size and pressure
- A wide range of flows to deliver the optimal application rate
- Only one moving part helps ensure product longevity
- Inlet size: 1/2" NPT male

## Design a Leaching System with the Mini-Wobbler

For proper field designing, use our Irrigation design tool WinSIPP™3 Mining. More information about this software is on page 42.

In this example, a mini-Wobbler CMS can deliver near 90% Coefficient Uniformity when used with at 20 x 20 ft (6 x 6 m) spacing, with 20 psi (1.38 bar) of pressure, and a #5 nozzle.

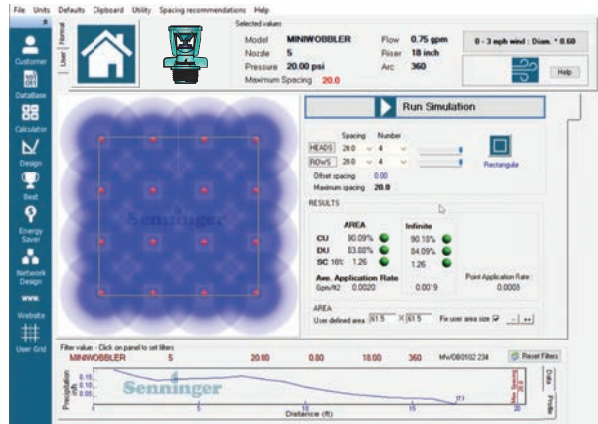

## Installation Options

### RISER STAKE

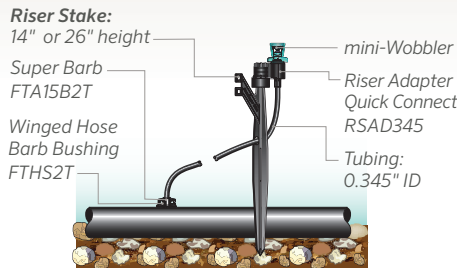

### HDPE RISER

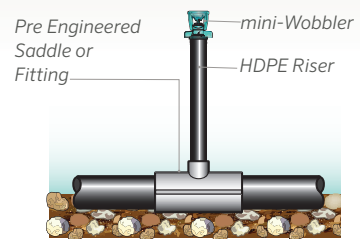

See installation options on page 10



**MINI-WOBBLER CMS PERFORMANCE DATA**

SPRINKLER BASE PRESSURE-US	psi			SPRINKLER BASE PRESSURE-METRIC	bar		
	15	20	25		1.03	1.38	1.72
<b>#4 Nozzle - Blue (1/16")</b>				<b>#4 Nozzle - Blue (1.59 mm)</b>			
Flow (gpm)	0.42	0.50	0.56	Flow (L/hr)	95	114	127
Diameter at 1.5 ft ht (ft)	26.5	28.0	28.0	Diameter at 0.46 m ht (m)	8.1	8.5	8.5
<b>#5 Nozzle - Brown (5/64")</b>				<b>#5 Nozzle - Brown (1.98 mm)</b>			
Flow (gpm)	0.64	0.75	0.84	Flow (L/hr)	145	170	191
Diameter at 1.5 ft ht (ft)	31.0	33.5	35.0	Diameter at 0.46 m ht (m)	9.4	10.2	10.7
<b>#6 Nozzle - Orange (3/32")</b>				<b>#6 Nozzle - Orange (2.38 mm)</b>			
Flow (gpm)	0.95	1.10	1.25	Flow (L/hr)	216	250	284
Diameter at 1.5 ft ht (ft)	33.0	36.0	37.0	Diameter at 0.46 m ht (m)	10.1	11.0	11.3
<b>#7 Nozzle - Dark Green (7/64")</b>				<b>#7 Nozzle - Dark Green (2.78 mm)</b>			
Flow (gpm)	1.30	1.51	1.69	Flow (L/hr)	295	343	384
Diameter at 1.5 ft ht (ft)	35.0	37.5	38.5	Diameter at 0.46 m ht (m)	10.7	11.4	11.7
<b>#8 Nozzle - Purple (1/8")</b>				<b>#8 Nozzle - Purple (3.18 mm)</b>			
Flow (gpm)	1.67	1.95	2.18	Flow (L/hr)	379	443	495
Diameter at 1.5 ft ht (ft)	35.5	38.5	38.0	Diameter at 0.46 m ht (m)	10.8	11.7	11.9

Sprinkler performance may vary with actual field conditions. Other nozzle sizes are available. Consult factory for specific performance data. Stream heights range from 1.5 to 3.0 ft (0.46 to 0.91 m) above nozzle based on pressure and nozzle size. Minimum recommended riser height is 1.5 ft (0.46 m).

# Xcel-Wobbler™ High & Mid Angle

Flow: 0.78 to 6.23 gpm (117 to 1415 L/hr)  
 Pressure: 10 to 20 psi (0.69 to 1.38 bar)



HIGH-ANGLE



MID-ANGLE



## Design a Leaching System with the Xcel-Wobbler

For proper field designing, use our Irrigation design tool WinSIPP™3 Mining. More information about this software is on page 42.

In this example, an Xcel-Wobbler High Angle CMS can deliver 90% Coefficient Uniformity when used with at 20 x 20 ft (6 x 6 m) with 20 psi (1.38 bar) of pressure, and a #9 nozzle.

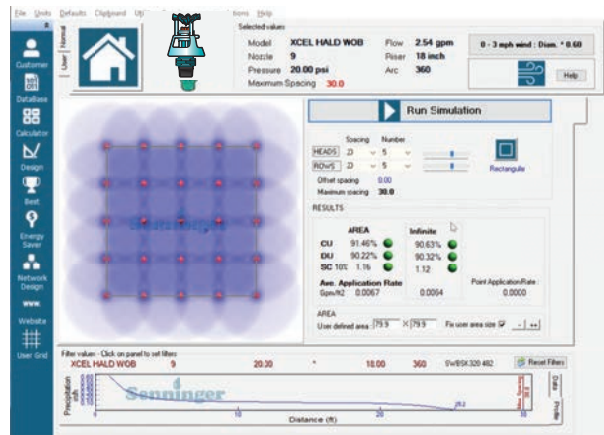

### FEATURES

- Outstanding uniformity
- High application efficiency at low operating pressure
- Various droplet sizes available based on selected nozzle size and pressure
- A wide range of flows to deliver the optimal application rate
- Only one moving part helps ensure product longevity
- Inlet size: 1/2" or 3/4" NPT male

### Installation Options

#### PVC RISER WITH PRESSURE REGULATOR

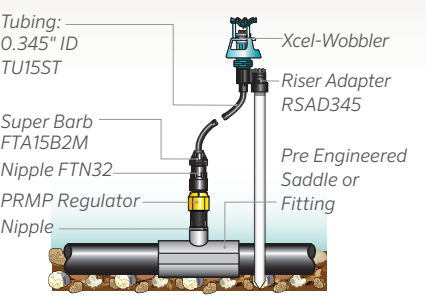

#### HDPE RISER

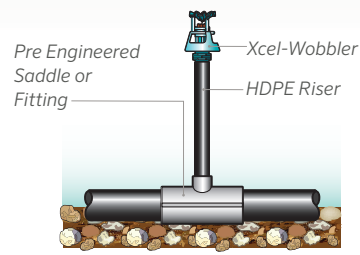

See installation options on page #10

# High & Mid Angle Xcel-Wobbler™

## XCEL-WOBBLER CMS PERFORMANCE DATA

SPRINKLER BASE PRESSURE-US	psi			SPRINKLER BASE PRESSURE-METRIC	bar		
	10	15	20		0.69	1.03	1.38
<b>#6 Nozzle - Gold (3/32")</b>				<b>#6 Nozzle - Gold (2.38 mm)</b>			
Flow (gpm)	0.78	0.95	1.10	Flow (L/hr)	177	216	250
HA Diameter at 1.5 ft ht (ft)	36.5	41.0	45.0	HA Diameter at 0.46 m ht (m)	11.1	12.5	13.7
MA Diameter at 1.5 ft ht (ft)	32.0	35.0	38.5	MA Diameter at 0.46 m ht (m)	9.8	10.7	11.7
<b>#7 Nozzle - Lime (7/64")</b>				<b>#7 Nozzle - Lime (2.78 mm)</b>			
Flow (gpm)	1.06	1.30	1.50	Flow (L/hr)	241	295	341
HA Diameter at 1.5 ft ht (ft)	40.0	46.5	47.0	HA Diameter at 0.46 m ht (m)	12.2	14.2	14.3
MA Diameter at 1.5 ft ht (ft)	33.0	36.5	40.5	MA Diameter at 0.46 m ht (m)	10.1	11.1	12.4
<b>#8 Nozzle - Lavender (1/8")</b>				<b>#8 Nozzle - Lavender (3.18 mm)</b>			
Flow (gpm)	1.40	1.71	1.98	Flow (L/hr)	318	388	450
HA Diameter at 1.5 ft ht (ft)	42.0	46.5	47.0	HA Diameter at 0.46 m ht (m)	12.8	14.2	14.3
MA Diameter at 1.5 ft ht (ft)	34.0	38.5	41.0	MA Diameter at 0.46 m ht (m)	10.4	11.7	12.5
<b>#9 Nozzle - Grey (9/64")</b>				<b>#9 Nozzle - Grey (3.57 mm)</b>			
Flow (gpm)	1.80	2.20	2.54	Flow (L/hr)	409	500	577
HA Diameter at 1.5 ft ht (ft)	44.0	47.0	50.5	HA Diameter at 0.46 m ht (m)	13.4	14.3	15.4
MA Diameter at 1.5 ft ht (ft)	34.5	40.5	42.0	MA Diameter at 0.46 m ht (m)	10.5	12.4	12.8
<b>#10 Nozzle - Turquoise (5/32")</b>				<b>#10 Nozzle - Turquoise (3.97 mm)</b>			
Flow (gpm)	2.22	2.72	3.14	Flow (L/hr)	504	618	713
HA Diameter at 1.5 ft ht (ft)	44.5	49.0	50.5	HA Diameter at 0.46 m ht (m)	13.6	14.9	15.4
MA Diameter at 1.5 ft ht (ft)	36.0	41.0	42.5	MA Diameter at 0.46 m ht (m)	11.0	12.5	13.0
<b>#11 Nozzle - Yellow (11/64")</b>				<b>#11 Nozzle - Yellow (4.37 mm)</b>			
Flow (gpm)	2.69	3.30	3.81	Flow (L/hr)	611	749	865
HA Diameter at 1.5 ft ht (ft)	44.5	50.5	51.5	HA Diameter at 0.46 m ht (m)	13.6	15.4	15.7
MA Diameter at 1.5 ft ht (ft)	36.0	41.5	43.0	MA Diameter at 0.46 m ht (m)	11.0	12.7	13.1
<b>#12 Nozzle - Red (3/16")</b>				<b>#12 Nozzle - Red (4.76 mm)</b>			
Flow (gpm)	3.23	3.96	4.57	Flow (L/hr)	734	899	1038
HA Diameter at 1.5 ft ht (ft)	46.0	50.5	52.0	HA Diameter at 0.46 m ht (m)	14.0	15.4	15.9
MA Diameter at 1.5 ft ht (ft)	36.5	41.5	44.5	MA Diameter at 0.46 m ht (m)	11.1	12.7	13.6
<b>#13 Nozzle - White (13/64")</b>				<b>#13 Nozzle - White (5.16 mm)</b>			
Flow (gpm)	3.80	4.65	5.38	Flow (L/hr)	863	1056	1222
HA Diameter at 1.5 ft ht (ft)	46.5	51.0	52.5	HA Diameter at 0.46 m ht (m)	14.2	15.6	16.0
MA Diameter at 1.5 ft ht (ft)	36.5	41.5	44.5	MA Diameter at 0.46 m ht (m)	11.1	12.7	13.6
<b>#14 Nozzle - Blue (7/32")</b>				<b>#14 Nozzle - Blue (5.56 mm)</b>			
Flow (gpm)	4.40	5.39	6.23	Flow (L/hr)	999	1224	1415
HA Diameter at 1.5 ft ht (ft)	47.0	51.0	53.0	HA Diameter at 0.46 m ht (m)	14.3	15.6	16.2
MA Diameter at 1.5 ft ht (ft)	37.0	42.5	45.0	MA Diameter at 0.46 m ht (m)	11.3	13.0	13.7

HA = high-angle, MA = mid-angle. Sprinkler performance may vary with actual field conditions. Other nozzle sizes are available. Consult factory for specific performance data. Stream heights range from 2.5 to 5.5 ft (0.8 to 1.7 m) above nozzle based on pressure and nozzle size.

# Wobbler® Standard and Low-Angle

Flow: 0.78 to 6.23 gpm (117 to 1415 L/hr)  
 Pressure: 10 to 20 psi (0.69 to 1.38 bar)



**STANDARD ANGLE**



**LOW ANGLE**



## Design a Leaching System with the Wobbler

In this example, a Wobbler CMS can deliver a 90% Coefficient Uniformity when used with at 22 x 22 ft (7 x 7 m) triangular spacing, with 20 psi (1.38 bar) of pressure, and a #9 nozzle.

### FEATURES

- Outstanding uniformity
- High application efficiency at low operating pressure
- Various droplet sizes available based on selected nozzle size and pressure.
- A wide range of flows to deliver the optimal application rate
- Only one moving part helps ensure product longevity
- Inlet size: 1/2" or 3/4" NPT male

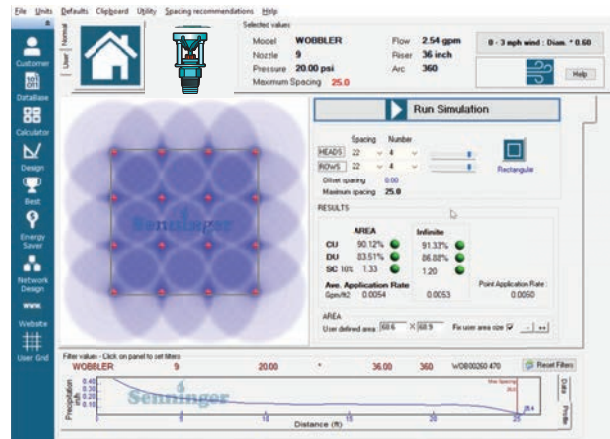

### Installation Options

#### SADDLE

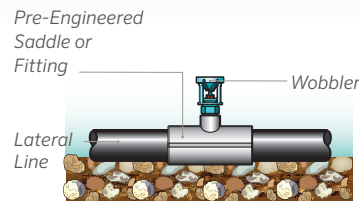

#### PRESSURE REGULATOR

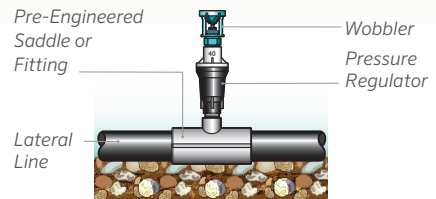

See installation options on page #10



# Standard and Low-Angle **Wobbler**<sup>®</sup>

## WOBBLER CMS PERFORMANCE DATA

SPRINKLER BASE PRESSURE-US	psi			SPRINKLER BASE PRESSURE-METRIC	bar		
	10	15	20		0.69	1.03	1.38
<b>#6 Nozzle - Gold (3/32")</b>				<b>#6 Nozzle - Gold (2.38 mm)</b>			
Flow (gpm)	0.78	0.95	1.10	Flow (L/hr)	177	216	250
SA Diameter at 1.5 ft ht (ft)	34.0	39.0	41.5	SA Diameter at 0.46 m ht (m)	10.4	11.9	12.7
LA Diameter at 1.5 ft ht (ft)	29.0	34.5	38.0	LA Diameter at 0.46 m ht (m)	8.8	10.5	11.6
<b>#7 Nozzle - Lime (7/64")</b>				<b>#7 Nozzle - Lime (2.78 mm)</b>			
Flow (gpm)	1.06	1.30	1.50	Flow (L/hr)	241	295	341
SA Diameter at 1.5 ft ht (ft)	36.5	41.5	43.5	SA Diameter at 0.46 m ht (m)	11.1	12.7	13.3
LA Diameter at 1.5 ft ht (ft)	31.5	37.0	40.0	LA Diameter at 0.46 m ht (m)	9.6	11.3	12.2
<b>#8 Nozzle - Lavender (1/8")</b>				<b>#8 Nozzle - Lavender (3.18 mm)</b>			
Flow (gpm)	1.40	1.71	1.98	Flow (L/hr)	318	388	450
SA Diameter at 1.5 ft ht (ft)	38.5	43.5	45.0	SA Diameter at 0.46 m ht (m)	11.7	13.3	13.7
LA Diameter at 1.5 ft ht (ft)	34.0	39.0	41.5	LA Diameter at 0.46 m ht (m)	10.4	11.9	12.7
<b>#9 Nozzle - Grey (9/64")</b>				<b>#9 Nozzle - Grey (3.57 mm)</b>			
Flow (gpm)	1.80	2.20	2.54	Flow (L/hr)	409	500	577
SA Diameter at 1.5 ft ht (ft)	40.5	45.5	46.5	SA Diameter at 0.46 m ht (m)	12.4	13.9	14.2
LA Diameter at 1.5 ft ht (ft)	35.5	40.5	42.5	LA Diameter at 0.46 m ht (m)	10.8	12.4	13.0
<b>#10 Nozzle - Turquoise (5/32")</b>				<b>#10 Nozzle - Turquoise (3.97 mm)</b>			
Flow (gpm)	2.22	2.72	3.14	Flow (L/hr)	504	618	713
SA Diameter at 1.5 ft ht (ft)	42.0	47.0	48.0	SA Diameter at 0.46 m ht (m)	12.8	14.3	14.6
LA Diameter at 1.5 ft ht (ft)	36.0	41.0	43.0	LA Diameter at 0.46 m ht (m)	11.0	12.5	13.1
<b>#11 Nozzle - Yellow (11/64")</b>				<b>#11 Nozzle - Yellow (4.37 mm)</b>			
Flow (gpm)	2.69	3.30	3.81	Flow (L/hr)	611	749	865
SA Diameter at 1.5 ft ht (ft)	43.0	48.0	49.0	SA Diameter at 0.46 m ht (m)	13.1	14.6	14.9
LA Diameter at 1.5 ft ht (ft)	36.5	42.0	43.5	LA Diameter at 0.46 m ht (m)	11.1	12.8	13.3
<b>#12 Nozzle - Red (3/16")</b>				<b>#12 Nozzle - Red (4.76 mm)</b>			
Flow (gpm)	3.23	3.96	4.57	Flow (L/hr)	734	899	1038
SA Diameter at 1.5 ft ht (ft)	44.0	49.0	50.0	SA Diameter at 0.46 m ht (m)	13.4	14.9	15.3
LA Diameter at 1.5 ft ht (ft)	37.0	42.5	44.0	LA Diameter at 0.46 m ht (m)	11.3	13.0	13.4
<b>#13 Nozzle - White (13/64")</b>				<b>#13 Nozzle - White (5.16 mm)</b>			
Flow (gpm)	3.80	4.65	5.38	Flow (L/hr)	863	1056	1222
SA Diameter at 1.5 ft ht (ft)	44.5	49.5	50.5	SA Diameter at 0.46 m ht (m)	13.6	15.1	15.4
LA Diameter at 1.5 ft ht (ft)	37.5	43.0	44.5	LA Diameter at 0.46 m ht (m)	11.4	13.1	13.6
<b>#14 Nozzle - Blue (7/32")</b>				<b>#14 Nozzle - Blue (5.56 mm)</b>			
Flow (gpm)	4.40	5.39	6.23	Flow (L/hr)	999	1224	1415
SA Diameter at 1.5 ft ht (ft)	45.0	50.0	51.0	SA Diameter at 0.46 m ht (m)	13.7	15.3	15.6
LA Diameter at 1.5 ft ht (ft)	38.0	43.5	45.0	LA Diameter at 0.46 m ht (m)	11.6	13.3	13.7

SA = standard-angle, LA = mid-angle. Sprinkler performance may vary with actual field conditions. Other nozzle sizes are available. Consult factory for specific performance data. Stream heights range from 2.5 to 5.5 ft (0.8 to 1.7 m) above nozzle based on pressure and nozzle size.

# Installation Options

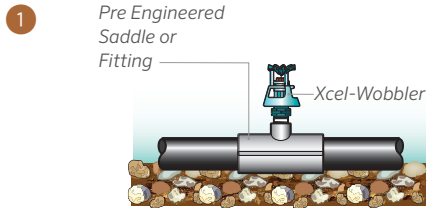

## SADDLE

The mini-Wobbler, Xcel-Wobbler or Wobbler can be mounted directly to a saddle or pre-engineered plastic female fitting.

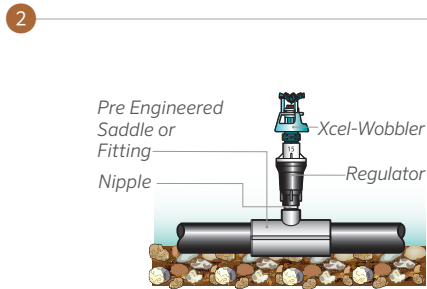

## PRESSURE REGULATOR

The mini-Wobbler, Xcel-Wobbler or Wobbler can be mounted directly to a pressure regulator. A nipple is required to connect the regulator to the saddle. Use a carbon or stainless-steel nipple for gold and silver leaching and a stainless-steel nipple for copper leaching.

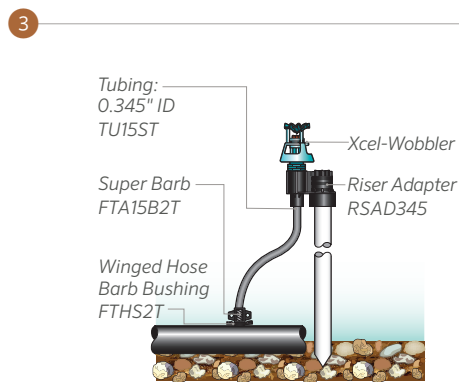

## PVC RISER

The mini-Wobbler or Xcel-Wobbler can be mounted on a PVC riser or the Senninger Riser Stake using the Senninger Riser Adapter. See page 40 for details.

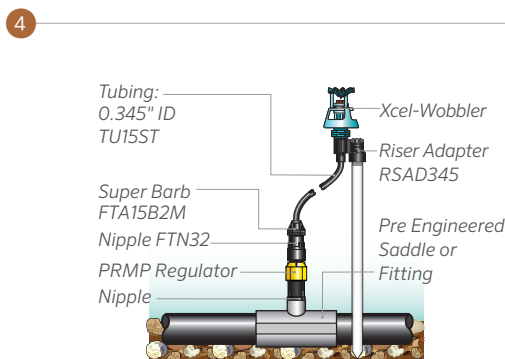

## PVC RISER WITH PRESSURE REGULATOR

The mini-Wobbler or Xcel-Wobbler can be mounted on a PVC riser or the Senninger Riser Stake and used with a pressure regulator.

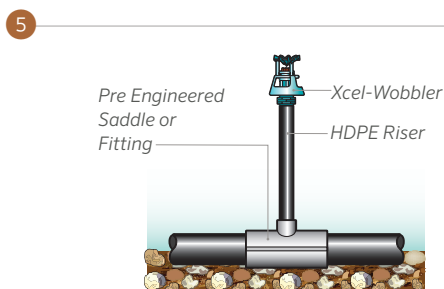

## HDPE RISER

The mini-Wobbler or Xcel-Wobbler can be mounted on a HDPE riser that connects to a saddle.

# Outstanding **Uniformity**

Senninger Wobbler® Technology utilizes a unique off-center rotary action that provides extremely uniform solution distribution, which is essential to maximizing metals recovery.

Wobbler Technology sprinklers are the most effective method for total solution contact due to the consistent droplet size that covers a full 360 degrees area instantaneously, so the solution reaches the ore surface with a gentle and even distribution.

This product line has been engineered and designed to provide optimal performance at low pressures, as low as 10 psi (0.69 bar), which not only minimizes evaporative losses but also saves energy and allows greater areas to be leached in less time. This can save money and increase productivity.

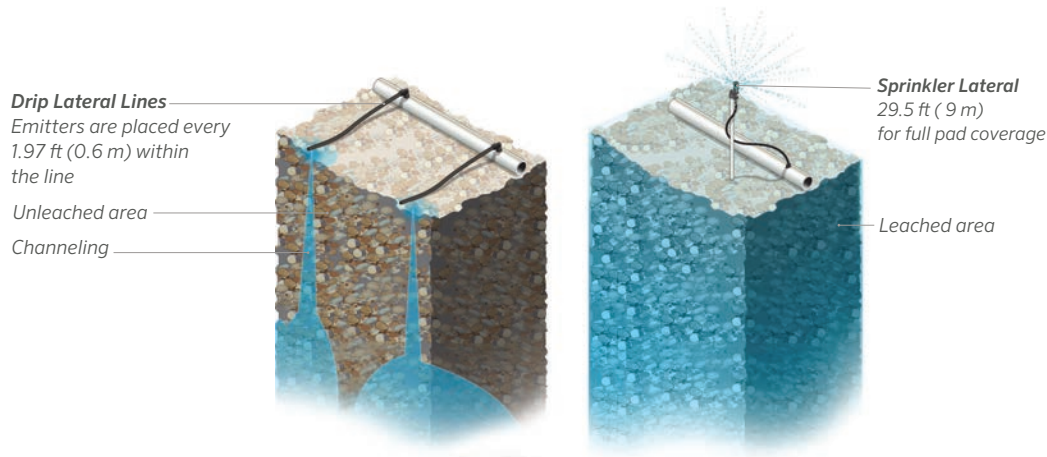

*Drip systems depend on the source point application of the solution, which promotes channeling. With a minimal lateral movement of the applied solution, drip systems have a challenge achieving the desired application rate.*

## Carbon Footprint

It is possible to reduce the carbon footprint in the mining industry by implementing technologies that not only perform more efficiently but also are more durable in the field. Consequently, they significantly decrease waste and pollution.

They have provided the highest water and energy efficiency while increasing productivity in the mining leaching process for decades.

Other technologies, like drip systems in mining, entail a high environmental cost due to the continual replacement of drip lines due to their high deterioration rate.



**LOW PRESSURE**  
**HIGH**  
**PERFORMANCE**

# Orifice Advantages

Wobbler® Technology sprinklers like the mini-Wobbler™ employ nozzle sizes that are larger than drip systems. This minimizes clogging issues without the need for excessive fine filtration, which can significantly increase operational costs for pad leaching.

## ORIFICE ADVANTAGE

### MINI-WOBBLER NOZZLE ORIFICES

 #6 Nozzle Orifice  
3/32" (2.38 mm)

 #7 Nozzle Orifice  
7/64" (2.78 mm)

 #8 Nozzle Orifice  
1/8" (3.17 mm)

### TYPICAL DRIP ORIFICE SIZE

0.052"  
(1.32 mm)



# Cost Savings Advantages

## WOBBLER TECHNOLOGY™

The Wobbler Technology sprinklers can be spaced 20 ft x 23 ft (6 m x 7 m) between sprinklers and lateral lines to deliver an optimal application rate. Material and installation costs are lower in both the short and long term. Plus, sprinklers are much easier to service.

## DRIP

Drip irrigation systems require spacing of about 2 ft or (0.61 m) between drip lines for the emitters to reach the optimal application rate. Installation costs and maintenance costs can be higher to correct clogged drip lines.

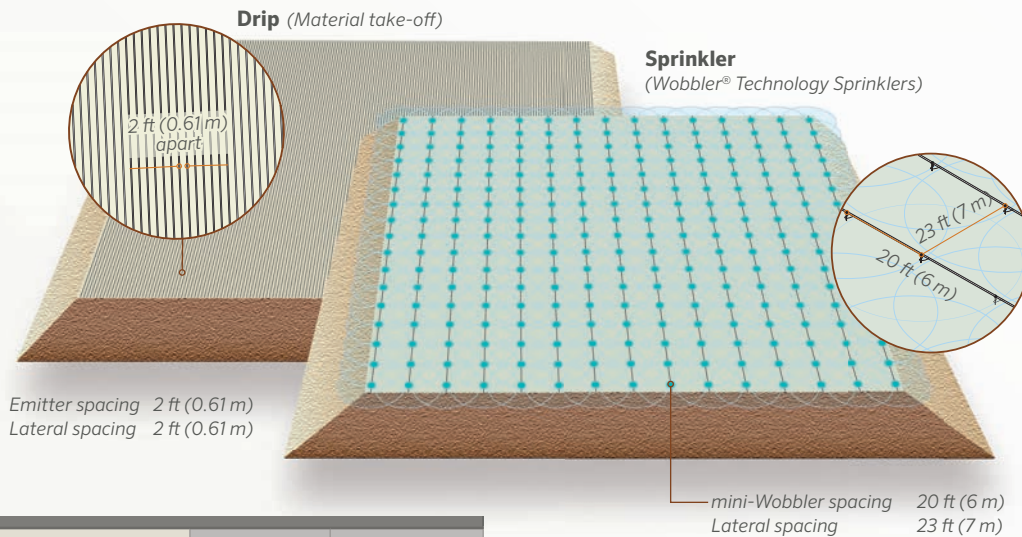

BILL OF MATERIAL	Sprinkler	Drip
16 mm PE lateral / (20 mm) PE lateral	4,700 linear ft (1,433 linear m)	54,000 linear ft (16,459 linear m)
Fittings	15	328
Emitters	255	27,000
ENERGY REQUIRED	Sprinkler	Drip
Pumps	60	60
Pipes	10	10
Fittings	2	2
Emitter Operating Pressure	15	15
Filtration	4	8
<b>TOTAL</b>	<b>91</b>	<b>95</b>

Based on Irri-Maker® design for pad 328 x 328 ft (100 x 100 m)

## ADDITIONAL ADVANTAGES

- Increases coverage efficiency
- Versatility of being moved and used repeatedly
- Visual confirmation of uniformity.
- Adjustable flow and application rates.
- Adapts to pad rinsing for reclamation.
- Can replace obsolete drip systems easily.

# Side Slope Leaching



Because Wobbler® Technology applies mining leach solutions with high uniformity, it can be adapted for use in hard-to-reach areas. Mineral extraction from side slopes is vital in mining. Wobbler sprinklers can help capture these resources efficiently with chemical solutions using low energy consumption.

## DESIGN A SIDE SLOPE LEACHING SYSTEM WITH WOBBLER TECHNOLOGY

Be sure to use the Irri-Maker® Software to design the most precise irrigation system on the side slope. It gives you the option to select a sprinkler type, pressures, valves, and pipe diameters based on flow velocities. More information about this software, on page 42.



## WOBBLER TECHNOLOGY TRANSFORMING ECOSYSTEMS

In the land recovery stages following mine closures, Wobbler Technology can provide efficient irrigation for those areas to help speed up the reforestation process.



### ADVANTAGES

- Reduce the carbon footprint by efficiently irrigating the trees in inert areas. Ultimately, this helps to provide oxygen to our planet.
- Provides efficient irrigation application in hard-to-reach areas.
- Increases coverage efficiency.
- Provides the versatility of being moved and used repeatedly.
- Affords visual confirmation of uniformity.
- Allows adjustable flow and application rates.
- Can replace obsolete drip system

# Sennode-BT Controllers

The battery-operated SENNODE-BT controller is enabled with powerful wireless Bluetooth® technology that can be easily managed from a smartphone. It's a reliable choice for areas where AC power is unavailable.

## BENEFITS

- Enabled with Bluetooth® technology with easy wireless configuration of schedules via Smartphone app.
- Unlimited device control and mapping via the same app.
- Models available for 1, 2, or 4 stations.



Scan the QR code for more information about the Sennode-BT controller.



# Electric Valves

Valves from Hunter Industries work seamlessly with high demand systems.



## BENEFITS

- Optional Filter Sentry® scours the filter screen in dirty water conditions
- Glass-filled nylon construction provides high pressure rating and reliability
- Double-beaded diaphragm seal design ensures leak-free performance
- Fabric-reinforced EPDM diaphragm and seat ensure greater performance in all water conditions
- Captive bonnet screws eliminate the possibility of lost parts during disassembly

# Other Solutions

Wobbler Technology sprinklers are also used for solar panels maintenance. The high uniformity of this product line helps keep them free of particles. As a result, the panels can absorb the greatest amount of solar energy the whole year round.





# Part-Circle

Flow: 2.42 to 16.1 gpm (550 to 3657 L/hr)  
 Pressure: 30 to 55 psi (2.07 to 3.70 bar)



Part-Circle impact sprinklers allow adjustments to match the desired area of coverage. They are mainly used in dust suppression.



### FEATURES

- Distributes water in a 60° to 360° adjustable pattern in 5° increments, no tools required
- Easily convertible to full-circle operation
- Covered reversing mechanism
- 23° nozzle trajectory for maximum radius of throw
- Inlet size: 3/4" NPT male (3/4" NPT female and 1" NPT female also available)

### 3123 PART-CIRCLE EFFLUENT PERFORMANCE DATA

SPRINKLER BASE PRESSURE-US	psi						SPRINKLER BASE PRESSURE-METRIC	bar					
	30	35	40	45	50	55		2.07	2.42	2.76	3.11	3.45	3.80
#8 Nozzle - Lav. (1/8")							#8 Nozzle - Lav. (3.18 mm)						
Flow (gpm)	2.42	2.62	2.79	2.97	3.12	3.28	Flow (L/hr)	550	595	634	675	709	745
Radius at 1.5 ft ht (ft)	38	39	40	41	42	42	Radius at 0.46 m ht (m)	11.6	11.9	12.2	12.5	12.8	12.8
#9 Nozzle - Grey (9/64")							#9 Nozzle - Grey (3.57 mm)						
Flow (gpm)	3.08	3.33	3.56	3.78	3.98	4.16	Flow (L/hr)	700	756	809	859	904	949
Radius at 1.5 ft ht (ft)	40	41	42	43	43	44	Radius at 0.46 m ht (m)	12.2	12.5	12.8	13.1	13.1	13.4
#10 Nozzle - Turq. (5/32")							#10 Nozzle - Turq. (3.97 mm)						
Flow (gpm)	3.82	4.13	4.41	4.68	4.93	5.17	Flow (L/hr)	868	938	1002	1063	1120	1174
Radius at 1.5 ft ht (ft)	41	43	44	45	45	46	Radius at 0.46 m ht (m)	12.5	13.1	13.4	13.7	13.7	14.0



### 4123 PART-CIRCLE EFFLUENT PERFORMANCE DATA

SPRINKLER BASE PRESSURE-US	psi						SPRINKLER BASE PRESSURE-METRIC	bar					
	30	35	40	45	50	55		2.07	2.42	2.76	3.11	3.45	3.80
<b>#10 Nozzle - Turquoise (5/32")</b>							<b>#10 Nozzle - Turquoise (3.97 mm)</b>						
Flow (gpm)	3.82	4.13	4.41	4.68	4.93	5.17	Flow (L/hr)	868	938	1002	1063	1120	1174
Radius at 1.5 ft ht (ft)	42	43	44	45	45	46	Radius at 0.46 m ht (m)	12.8	13.1	13.4	13.7	13.7	14.0
<b>#11 Nozzle - Yellow (11/64")</b>							<b>#11 Nozzle - Yellow (4.37 mm)</b>						
Flow (gpm)	4.63	5.00	5.34	5.67	5.98	6.27	Flow (L/hr)	1052	1136	1213	1288	1358	1424
Radius at 1.5 ft ht (ft)	44	45	46	47	48	48	Radius at 0.46 m ht (m)	13.3	13.7	14.0	14.3	14.5	14.6
<b>#12 Nozzle - Red (3/16")</b>							<b>#12 Nozzle - Red (4.76 mm)</b>						
Flow (gpm)	5.52	5.97	6.37	6.76	7.13	7.48	Flow (L/hr)	1254	1356	1447	1535	1619	1699
Radius at 1.5 ft ht (ft)	45	46	48	49	50	51	Radius at 0.46 m ht (m)	13.6	14.0	14.5	14.9	15.2	15.4
<b>#13 Nozzle - White (13/64")</b>							<b>#13 Nozzle - White (5.16 mm)</b>						
Flow (gpm)	6.50	7.02	7.49	7.95	8.38	8.80	Flow (L/hr)	1476	1594	1701	1806	1903	1999
Radius at 1.5 ft ht (ft)	45	47	48	50	51	51	Radius at 0.46 m ht (m)	13.7	14.2	14.6	15.1	15.4	15.5

### 5123 PART-CIRCLE EFFLUENT PERFORMANCE DATA

SPRINKLER BASE PRESSURE-US	psi						SPRINKLER BASE PRESSURE-METRIC	bar					
	30	35	40	45	50	55		2.07	2.42	2.76	3.11	3.45	3.80
<b>#13 Nozzle - White (13/64")</b>							<b>#13 Nozzle - White (5.16 mm)</b>						
Flow (gpm)	6.50	7.02	7.49	7.95	8.38	8.80	Flow (L/hr)	1476	1594	1701	1806	1903	1999
Radius at 1.5 ft ht (ft)	45	47	48	50	51	51	Radius at 0.46 m ht (m)	13.7	14.3	14.6	15.2	15.5	15.5
<b>#14 Nozzle - Blue (7/32")</b>							<b>#14 Nozzle - Blue (5.56 mm)</b>						
Flow (gpm)	7.49	8.09	8.63	9.17	9.66	10.1	Flow (L/hr)	1701	1837	1960	2083	2194	2294
Radius at 1.5 ft ht (ft)	46	47	49	50	51	52	Radius at 0.46 m ht (m)	14.0	14.3	14.9	15.2	15.5	15.8
<b>#15 Nozzle - Dark Brown (15/64")</b>							<b>#15 Nozzle - Dark Brown (5.95 mm)</b>						
Flow (gpm)	8.51	9.19	9.81	10.4	11.0	11.5	Flow (L/hr)	1933	2087	2228	2362	2498	2612
Radius at 1.5 ft ht (ft)	46	48	50	51	52	53	Radius at 0.46 m ht (m)	14.0	14.6	15.2	15.5	15.8	16.2
<b>#16 Nozzle - Orange (1/4")</b>							<b>#16 Nozzle - Orange (6.35 mm)</b>						
Flow (gpm)	9.63	10.4	11.1	11.8	12.4	13.0	Flow (L/hr)	2187	2362	2521	2680	2816	2953
Radius at 1.5 ft ht (ft)	47	50	51	53	54	55	Radius at 0.46 m ht (m)	14.3	15.2	15.5	16.2	16.5	16.8
<b>#17 Nozzle - Dark Green (17/64")</b>							<b>#17 Nozzle - Dark Green (6.75 mm)</b>						
Flow (gpm)	10.7	11.6	12.3	13.1	13.8	14.5	Flow (L/hr)	2430	2635	2794	2975	3134	3293
Radius at 1.5 ft ht (ft)	47	50	52	54	55	56	Radius at 0.46 m ht (m)	14.3	15.2	15.8	16.5	16.8	17.1
<b>#18 Nozzle - Purple (9/32")</b>							<b>#18 Nozzle - Purple (7.14 mm)</b>						
Flow (gpm)	11.9	12.9	13.7	14.6	15.4	16.1	Flow (L/hr)	2703	2903	3112	3316	3498	3657
Radius at 1.5 ft ht (ft)	47	50	53	55	56	57	Radius at 0.46 m ht (m)	14.3	15.2	16.2	16.8	17.1	17.4

Sprinkler performance may vary with actual field conditions. Radius shown is for standard straight bore nozzles and stream straightening vanes. Other nozzles and/or vane combinations are available. Consult factory for specific performance data. Stream heights range from 6.0 to 10.0 ft (1.8 to 3.1 m) above nozzle based on pressure nozzle size.

# Dust Suppression



Sprinklers are often used for dust suppression by applying water that penetrates the ground to 1.5 and 2 ft (0.5 and 0.61 m). This can reduce the number of particles generated by as much as 95%. Additionally, the water droplets intercept dust particles mid-air pulling them down to the ground.

### Roadways

Senninger Part-Circle sprinklers are used along roadways to minimize dust and improve visibility for trucks and equipment. Minimizing dust helps reduce the need to wash equipment windshields as often.

### Mine Perimeter

Sprinkler systems can be used to help create a barrier along the mine perimeter to help reduce dust migration.

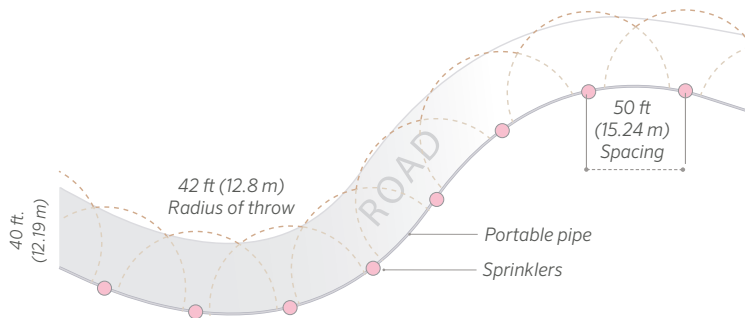

LAYOUT EXAMPLE

Sprinkler	Indicated by ●
Model	3123 Part-Circle: nozzle #9 (9/64")
Note	Pressure regulator recommended at 40 psi (2.76 bar)
Radius	42 ft (12.8 m)
Flow	3.56 gpm (809 L/hr)

## Advantages of sprinklers over other dust suppression technologies

- Reduce water use by up to 90% over traditional dust control methods.
- Use less energy and require less maintenance than traditional methodologies.
- Reduce the carbon footprint associated with costly mobile watering systems.
- Improve efficiency when connected to controllers to automate scheduled run times.
- Reduce traffic dust on mining roads and help improve overall daily operating conditions.
- Help reduce scheduled truck and equipment maintenance.



# 80 Series

Flow: 25.2 to 88.7 gpm (5724 to 20146 L/hr)  
Pressure: 40 to 70 psi (2.76 to 4.83 bar)



## FEATURES

- Splash arm spring and bearing enclosed for better resistance to corrosion and environmental extremes
- Constructed of engineering-grade thermoplastics and specially selected stainless-steel components for excellent corrosion resistance
- Heavy-duty design to withstand rugged mining conditions
- Single-nozzle design provides greater resistance to clogging
- Double-nozzle design also available for greater uniformity
- Inlet sizes: 1 ¼" NPT male or female, 1 ½" NPT male, 1 ¼" BSPT male
- 1" model (7025) also available for gold and silver.



## Installation Option

*Impact sprinklers that are mounted onto a riser should be stabilized to counteract the sprinkler's thrust. When using risers in gold and silver mining, use carbon steel or stainless-steel pipe. When using risers in acid copper leaching, use stainless-steel pipe.*

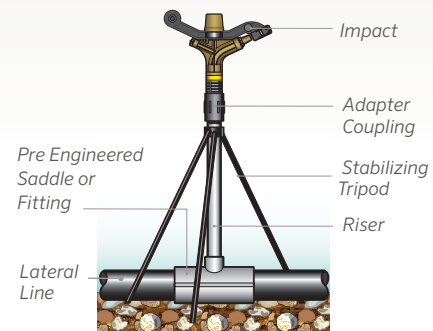

## 80 Series

**8025 CMS IMPACT SPRINKLER PERFORMANCE DATA**  
**1 ¼" & 1 ½" NPT**

SPRINKLER BASE PRESSURE-US	psi				SPRINKLER BASE PRESSURE-US	bar			
	40	50	60	70		2.76	3.45	4.14	4.83
<b>#24 Nozzle - (3/8")</b>					<b>#24 Nozzle - (9.53 mm)</b>				
Flow (gpm)	25.2	28.2	30.9	33.3	Flow (L/hr)	5724	6405	7018	7563
Diameter at 1.5 ft ht (ft)	134	144	154	159	Diameter at 0.46 m ht (m)	41	44	47	48
<b>#26 Nozzle - (13/32")</b>					<b>#26 Nozzle - (10.32 mm)</b>				
Flow (gpm)	29.3	32.7	35.9	38.7	Flow (L/hr)	6655	7427	8154	8790
Diameter at 1.5 ft ht (ft)	142	152	161	166	Diameter at 0.46 m ht (m)	43	46	49	51
<b>#28 Nozzle - (7/16")</b>					<b>#28 Nozzle - (11.11 mm)</b>				
Flow (gpm)	33.9	38.0	41.6	44.9	Flow (L/hr)	7700	8631	9448	10198
Diameter at 1.5 ft ht (ft)	148	157	166	171	Diameter at 0.46 m ht (m)	45	48	51	52
<b>#30 Nozzle - (15/32")</b>					<b>#30 Nozzle - (11.91 mm)</b>				
Flow (gpm)	38.6	43.1	47.2	51.0	Flow (L/hr)	8767	9789	10720	11583
Diameter at 1.5 ft ht (ft)	153	162	170	175	Diameter at 0.46 m ht (m)	47	49	52	53
<b>#32 Nozzle - (1/2")</b>					<b>#32 Nozzle - (12.7 mm)</b>				
Flow (gpm)	43.9	49.0	53.7	58.0	Flow (L/hr)	9971	11129	12197	13173
Diameter at 1.5 ft ht (ft)	156	165	173	179	Diameter at 0.46 m ht (m)	48	50	53	55
<b>#34 Nozzle - (17/32")</b>					<b>#34 Nozzle - (13.49 mm)</b>				
Flow (gpm)	49.5	55.4	60.7	65.5	Flow (L/hr)	11243	12583	13786	14877
Diameter at 1.5 ft ht (ft)	159	168	176	183	Diameter at 0.46 m ht (m)	48	51	54	56
<b>#36 Nozzle - (9/16")</b>					<b>#36 Nozzle - (14.29 mm)</b>				
Flow (gpm)	55.5	62.1	68.0	73.5	Flow (L/hr)	12605	14104	15444	16694
Diameter at 1.5 ft ht (ft)	161	170	178	187	Diameter at 0.46 m ht (m)	49	52	54	57
<b>#38 Nozzle - (19/32")</b>					<b>#38 Nozzle - (15.08 mm)</b>				
Flow (gpm)	59.9	66.9	73.3	79.2	Flow (L/hr)	13605	15195	16648	17988
Diameter at 1.5 ft ht (ft)	163	172	180	190	Diameter at 0.46 m ht (m)	50	52	55	58
<b>#40 Nozzle - (5/8")</b>					<b>#40 Nozzle - (15.88 mm)</b>				
Flow (gpm)	67.1	75.0	82.1	88.7	Flow (L/hr)	15240	17034	18647	20146
Diameter at 1.5 ft ht (ft)	165	174	182	192	Diameter at 0.46 m ht (m)	50	53	55	59

Sprinkler performance may vary with actual field conditions. Diameters shown are for standard straight bore nozzles and stream-straightening vanes (black). Other nozzles are available. Consult factory for specific performance data. Stream heights range from 12.5 to 28.0 ft (3.8 to 8.5 m) above nozzle based on pressure and nozzle size.

# Super Spray®

Flow: 2.75 to 8.79 gpm (625 to 1996 L/hr)  
 Pressure: 15 to 30 psi (1.04 to 2.07 bar)



### Deflector Pads

- Evaporation (black)
- Convex Smooth (green)
- Flat Smooth (black)



### Easy Clean Nozzle Design

Just pinch and pull to remove the nozzle then place and click to re-install. No need to disassemble or remove the sprinkler. Nozzle sizes are easily identifiable with color-coding and embossing on the ears, including half sizes (orifice diameters in 1/28 inch increments).

### FEATURES

- No moving parts for longer life
- Built for strength and durability using high-impact engineering-grade thermoplastics
- Interchangeable deflector pads to customize spray angle and droplet size
- Easy clean nozzle, color coded by size
- Inlet size: 3/4" NPT male or female

### STREAM HEIGHT ABOVE SPRAY PAD

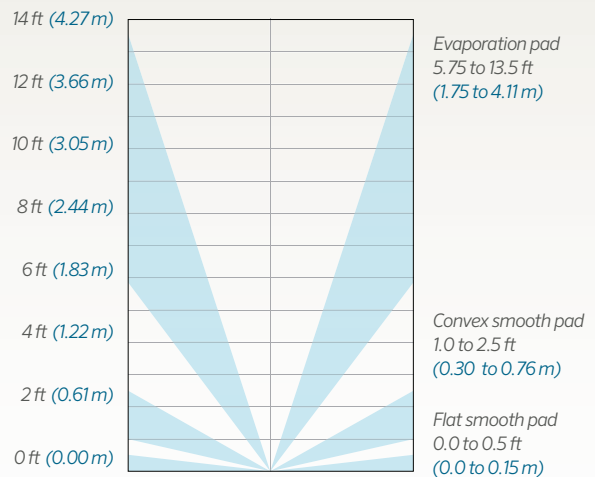

Evaporation results will vary depending on wind, temperature, humidity and other factors. These variables must be considered when calculating evaporative performance.



**Super Spray for Evaporation**

To help decrease the water in the tailings and storage dams, especially in regions or seasons of high rainfall, sprinklers can help evaporate solutions.

The Senninger Super Spray sprinkler uses less energy and requires less maintenance than traditional methodologies. These sprinklers can be connected to controllers to schedule run times that best suit mining operations.

**SUPER SPRAY PERFORMANCE DATA**

SPRINKLER BASE PRESSURE-US	psi				SPRINKLER BASE PRESSURE-METRIC	bar			
	15	20	25	30		1.04	1.38	1.73	2.07
<b>#10 Nozzle - Turquoise (5/32")</b>					<b>#10 Nozzle - Turquoise (3.97 mm)</b>				
Flow (gpm)	2.75	3.17	3.55	3.88	Flow (L/hr)	625	720	806	881
Evaporation Pad - Diameter at 1.5 ft ht (ft)	22.0	24.0	25.0	25.0	Evaporation Pad - Diameter at 0.46 m ht (m)	6.7	7.3	7.6	7.6
Convex-Smooth Pad - Diameter at 1.5 ft ht (ft)	24.5	28.5	31.5	31.5	Convex-Smooth Pad - Diameter at 0.46 m ht (m)	7.5	8.7	9.6	9.6
Flat-Smooth Pad - Diameter at 1.5 ft ht (ft)	22.0	24.0	26.0	27.0	Flat-Smooth Pad - Diameter at 0.46 m ht (m)	6.7	7.3	7.9	8.2
<b>#11 Nozzle - Yellow (11/64")</b>					<b>#11 Nozzle - Yellow (4.37 mm)</b>				
Flow (gpm)	3.33	3.84	4.30	4.71	Flow (L/hr)	756	872	977	1070
Evaporation Pad - Diameter at 1.5 ft ht (ft)	23.5	25.5	26.0	25.5	Evaporation Pad - Diameter at 0.46 m ht (m)	7.2	7.8	7.9	7.8
Convex-Smooth Pad - Diameter at 1.5 ft ht (ft)	26.5	30.5	33.5	33.5	Convex-Smooth Pad - Diameter at 0.46 m ht (m)	8.1	9.3	10.2	10.2
Flat-Smooth Pad - Diameter at 1.5 ft ht (ft)	22.5	24.5	26.5	27.5	Flat-Smooth Pad - Diameter at 0.46 m ht (m)	6.9	7.5	8.1	8.4
<b>#12 Nozzle - Red (3/16")</b>					<b>#12 Nozzle - Red (4.76 mm)</b>				
Flow (gpm)	3.97	4.58	5.12	5.61	Flow (L/hr)	902	1040	1163	1274
Evaporation Pad - Diameter at 1.5 ft ht (ft)	25.0	27.0	27.0	26.0	Evaporation Pad - Diameter at 0.46 m ht (m)	7.6	8.2	8.2	7.9
Convex-Smooth Pad - Diameter at 1.5 ft ht (ft)	28.0	32.0	35.0	35.0	Convex-Smooth Pad - Diameter at 0.46 m ht (m)	8.5	9.8	10.7	10.7
Flat-Smooth Pad - Diameter at 1.5 ft ht (ft)	23.0	25.0	27.0	28.0	Flat-Smooth Pad - Diameter at 0.46 m ht (m)	7.0	7.6	8.2	8.5
<b>#13 Nozzle - White (13/64")</b>					<b>#13 Nozzle - White (5.16 mm)</b>				
Flow (gpm)	4.66	5.38	6.02	6.59	Flow (L/hr)	1058	1222	1367	1497
Evaporation Pad - Diameter at 1.5 ft ht (ft)	26.5	28.5	28.0	26.5	Evaporation Pad - Diameter at 0.46 m ht (m)	8.1	8.7	8.5	8.1
Convex-Smooth Pad - Diameter at 1.5 ft ht (ft)	29.5	33.5	36.0	36.0	Convex-Smooth Pad - Diameter at 0.46 m ht (m)	9.0	10.2	11.0	11.0
Flat-Smooth Pad - Diameter at 1.5 ft ht (ft)	23.5	25.5	27.5	28.5	Flat-Smooth Pad - Diameter at 0.46 m ht (m)	7.2	7.8	8.3	8.7
<b>#14 Nozzle - Blue (7/32")</b>					<b>#14 Nozzle - Blue (5.56 mm)</b>				
Flow (gpm)	5.41	6.25	6.99	7.65	Flow (L/hr)	1229	1420	1588	1738
Evaporation Pad - Diameter at 1.5 ft ht (ft)	28.0	29.5	28.5	27.0	Evaporation Pad - Diameter at 0.46 m ht (m)	8.5	9.0	8.7	8.2
Convex-Smooth Pad - Diameter at 1.5 ft ht (ft)	31.0	35.0	37.0	37.0	Convex-Smooth Pad - Diameter at 0.46 m ht (m)	9.5	10.7	11.3	11.3
Flat-Smooth Pad - Diameter at 1.5 ft ht (ft)	23.5	26.0	28.0	29.0	Flat-Smooth Pad - Diameter at 0.46 m ht (m)	7.2	7.9	8.5	8.8
<b>#15 Nozzle - Dark Brown (15/64")</b>					<b>#15 Nozzle - Dark Brown (5.95 mm)</b>				
Flow (gpm)	6.22	7.18	8.03	8.79	Flow (L/hr)	1413	1631	1824	1996
Evaporation Pad - Diameter at 1.5 ft ht (ft)	29.0	30.0	29.0	27.5	Evaporation Pad - Diameter at 0.46 m ht (m)	8.8	9.2	8.8	8.4
Convex-Smooth Pad - Diameter at 1.5 ft ht (ft)	32.0	36.0	38.0	38.0	Convex-Smooth Pad - Diameter at 0.46 m ht (m)	9.8	11.0	11.6	11.6
Flat-Smooth Pad - Diameter at 1.5 ft ht (ft)	24.0	26.5	28.5	29.5	Flat-Smooth Pad - Diameter at 0.46 m ht (m)	7.3	8.1	8.7	9.0

Sprinkler performance may vary with actual field conditions. Other nozzle sizes are available. Consult factory for specific performance data.

# Pressure Regulation Overview

Pressure regulators help ensure proper sprinkler performance by controlling excessive and varying inlet pressure to constant outlet pressure. This helps maintain the sprinkler’s pattern and application uniformity to maintain the overall efficiency of the application system.

## FEATURES

- Constructed out of high-impact thermoplastics with a stainless-steel compression spring
- Pressure tested to ensure quality and performance
- Very low hysteresis and friction loss
- Several models available based on pressures, flow range, and connection options



Every irrigation system experiences pressure fluctuations resulting in unwanted flow deviations and over and under-leaching. These fluctuations occur with elevation changes within the irrigated area, pressure loss through pipes and fittings, fluctuations when zones cycle on or off, system demand change on large projects with multiple water sources, and activation of large water guns.



	PRMP	PRL	PMR-MF
Flow Range	0.5 - 7 gpm (114 - 1590 L/hr)	0.5 - 8 gpm (114 - 1817 L/hr)	2 - 20 gpm (454 - 4543 L/hr)
Preset Operating Pressure	10 - 40 psi (0.69 - 2.76 bar)	6 - 40 psi (0.41 - 2.76 bar)	6 - 60 psi (0.41 - 4.14 bar)
Maximum Inlet Pressure	120 psi (8.27 bar)	120 psi (8.27 bar)	140 psi (9.65 bar)
Inlet Sizes	3/4" F hose, 3/4" F NPT	3/4" F NPT, 3/4" F hose	3/4" F NPT, 1" F NPT, 1" F BSPT
Outlet Sizes	3/4" M hose, 3/4" M NPT	3/4" F NPT	3/4" F NPT, 1" F NPT, 1" F BSPT



	PR-HF	PRU	PRLV	PRXF-LV
Flow Range	10 - 32 gpm (2271 - 7268 L/hr)	20 -100 gpm (4543 - 22713 L/hr)	0.5 -18 gpm (114 - 4088 L/hr)	Max: 75 gpm (Max: 17034 L/hr)
Operating Pressure	10 - 50 psi (0.69 - 3.45 bar)	10 - 60 psi (0.69 - 4.14 bar)	30 - 60 psi (2.07 - 4.14 bar)	20 - 60 psi (1.38 - 4.14 bar)
Maximum Inlet Pressure	130 psi (8.96 bar)	140 psi (9.65 bar)	125 psi (8.62 bar)	125 psi (8.62 bar)
Inlet Sizes	1 1/4" F NPT, 1 1/4" F BSPT	2" F NPT, 2" F BSPT	3/4" F NPT, 1" F NPT	3" F slip
Outlet Sizes	1" F NPT, 1 1/4" F NPT, 1" F BSPT, 1 1/4" F BSPT	2" F NPT, 2" F BSPT	3/4" F NPT, 1" F NPT	3" F slip



# Overview Pressure Regulation

## HOW DO PRESSURE REGULATORS WORK?

Water travels through the inlet of the regulator across a fixed seat into the critical flow area. Water then enters a hollow cylinder or throttling stem attached to a diaphragm. Increasing inlet pressure causes the valve to close. Decreasing inlet pressure allows the valve to open. The regulated outlet pressure is determined by the spring's compressive strength.

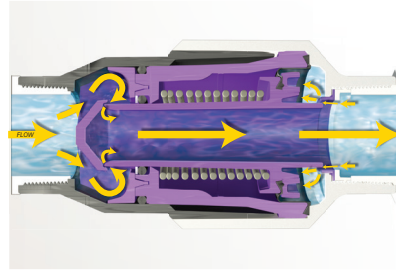

## Dynamic Pressure Regulators

Dynamic pressure regulators must always be installed **downstream** from all shut-off valves and filters in the proper direction. Each model has a directional arrow on the side that shows the direction of the flow. This arrow should point downstream, toward the sprinklers and emitters.

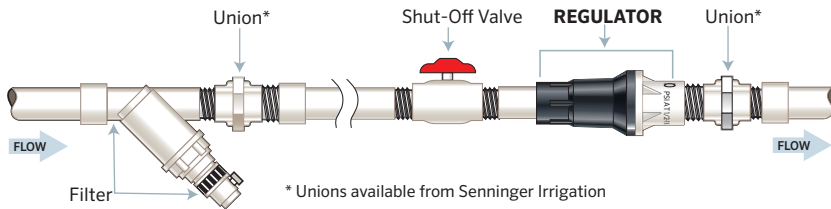

## Static Pressure Regulators

Static pressure regulators, like our Pressure Regulating Limit Valve (PRLV and PRXF-LV) must always be installed **upstream** from all shut-off valves and filters in the proper direction. Each model has a directional arrow on the side that shows the direction of the flow. This arrow should point downstream, toward the sprinklers and emitters.

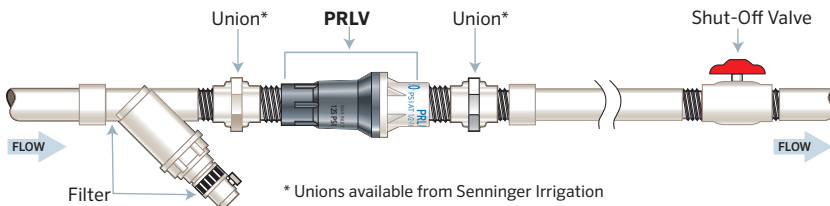

# PRMP Pressure Regulator Mining Prospector

Flow: 0.5 to 7.0 gpm (114 to 1590 L/hr)  
 Pressure: 10 to 40 psi (0.69 to 2.76 bar)

## FEATURES

- Maintains a constant preset outlet pressure while handling varying inlet pressures
- Inlet sizes: 3/4" hose female, 3/4" NPT female
- Outlet sizes: 3/4" hose male, 3/4" NPT male
- Tamper-proof housing
- Very low hysteresis and friction losses
- Pressure-tested for accuracy
- No external metal parts for excellent
- Corrosion resistance

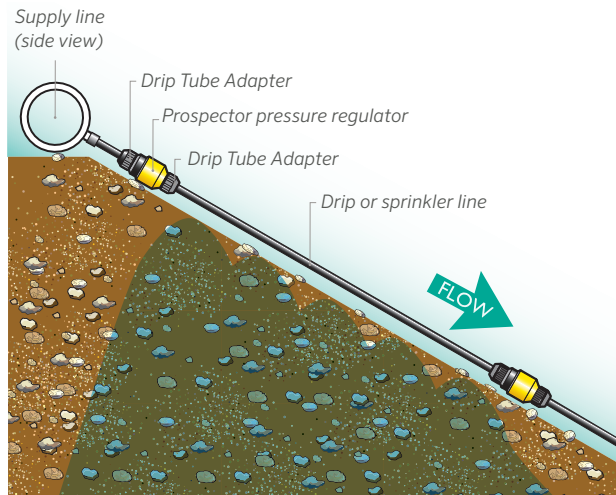

PRMP DESIGN CRITERIA	Preset Operating Pressure	Maximum Inlet Pressure	Flow Range	
			gpm	L/hr
PRMP 10	10 psi (0.69 bar)	90 psi (6.20 bar)	0.5 - 7	114 - 1590
PRMP 15	15 psi (1.03 bar)	95 psi (6.55 bar)	0.5 - 7	114 - 1590
PRMP 20	20 psi (1.38 bar)	100 psi (6.89 bar)	0.5 - 7	114 - 1590
PRMP 25	25 psi (1.72 bar)	105 psi (7.24 bar)	0.5 - 7	114 - 1590
PRMP 30	30 psi (2.07 bar)	110 psi (7.58 bar)	0.5 - 7	114 - 1590
PRMP 35	35 psi (2.41 bar)	115 psi (7.93 bar)	0.5 - 7	114 - 1590
PRMP 40	40 psi (2.76 bar)	120 psi (8.27 bar)	0.5 - 7	114 - 1590

Spec sheets are available online at [senninger.com](http://senninger.com)

The pressure regulator shall maintain the predetermined pressure provided that the inlet pressure is at least 5 psi (0.34 bar) above the expected outlet pressure, but not exceeding the maximum inlet pressure as shown in this chart.

Pressure regulators should always be installed downstream of all shut-off valves.

# Pressure Regulator Mining Prospector **PRMP**

## PRMP Performance Curve

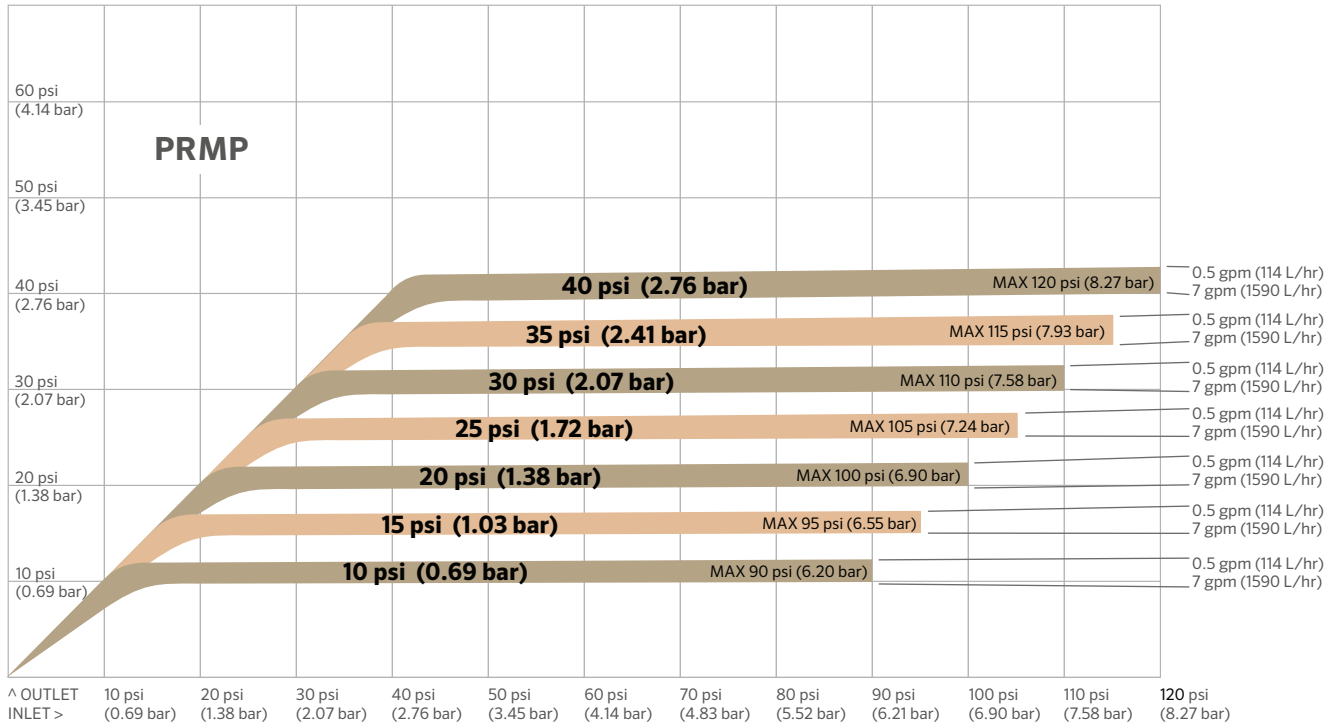

Every pressure regulator is designed to operate at a minimum and maximum inlet pressure and a predetermined flow range. This regulator performance curve illustrates how the PRMP will perform within the range of inlet pressures and flows.

The Y-axis shows outlet pressure, and the X-axis shows inlet pressure.

In this chart, the band for the 30 psi (2.07 bar) model shows the performance at various flows. At the lowest flow (0.5 gpm or 114 L/hr), the regulator will maintain an actual outlet pressure slightly higher than 30 psi (2.07 bar). In contrast, at the highest flow (7 gpm or 1590 L/hr), the actual outlet pressure will be slightly lower than 30 psi (2.07 bar)\*.

\*Source: Rogers, Shaw, Pragada, & Alam, 2010.

# PRL Pressure Regulator Low Flow

Flow: 0.5 to 8.0 gpm (114 to 1817 L/hr)  
 Pressure: 6 to 40 psi (0.41 to 2.76 bar)



## FEATURES

- Maintains a constant preset outlet pressure while handling varying inlet pressures
- Inlet sizes: Inlet sizes: 3/4" NPT female, 3/4" hose female
- Outlet sizes: 3/4" NPT female
- Tamper-proof housing
- Very low hysteresis and friction losses
- Pressure-tested for accuracy
- No external metal parts for excellent corrosion resistance

PRL-CMS DESIGN CRITERIA	Preset Operating Pressure	Maximum Inlet Pressure	Flow Range	
			gpm	L/hr
PRL 6 CMS	6 psi (0.41 bar)	80 psi (5.51 bar)	0.5 - 5	114 - 1136
PRL 10 CMS	10 psi (0.69 bar)	90 psi (6.20 bar)	0.5 - 8	114 - 1817
PRL 12 CMS	12 psi (0.83 bar)	90 psi (6.20 bar)	0.5 - 8	114 - 1817
PRL 15 CMS	15 psi (1.03 bar)	95 psi (6.55 bar)	0.5 - 8	114 - 1817
PRL 20 CMS	20 psi (1.38 bar)	100 psi (6.89 bar)	0.5 - 8	114 - 1817
PRL 25 CMS	25 psi (1.72 bar)	105 psi (7.24 bar)	0.5 - 8	114 - 1817
PRL 30 CMS	30 psi (2.07 bar)	110 psi (7.58 bar)	0.5 - 8	114 - 1817
PRL 35 CMS	35 psi (2.41 bar)	115 psi (7.93 bar)	0.5 - 8	114 - 1817
PRL 40 CMS	40 psi (2.76 bar)	120 psi (8.27 bar)	0.5 - 8	114 - 1817

Spec sheets are available online at [senninger.com](http://senninger.com)

*The pressure regulator shall maintain the predetermined pressure provided that the inlet pressure is at least 5 psi (0.34 bar) above the expected outlet pressure, but not exceeding the maximum inlet pressure as shown in this chart.*

*Pressure regulators should always be installed downstream of all shut-off valves.*

# Pressure Regulator Low Flow **PRL**

## PRL Performance Curve

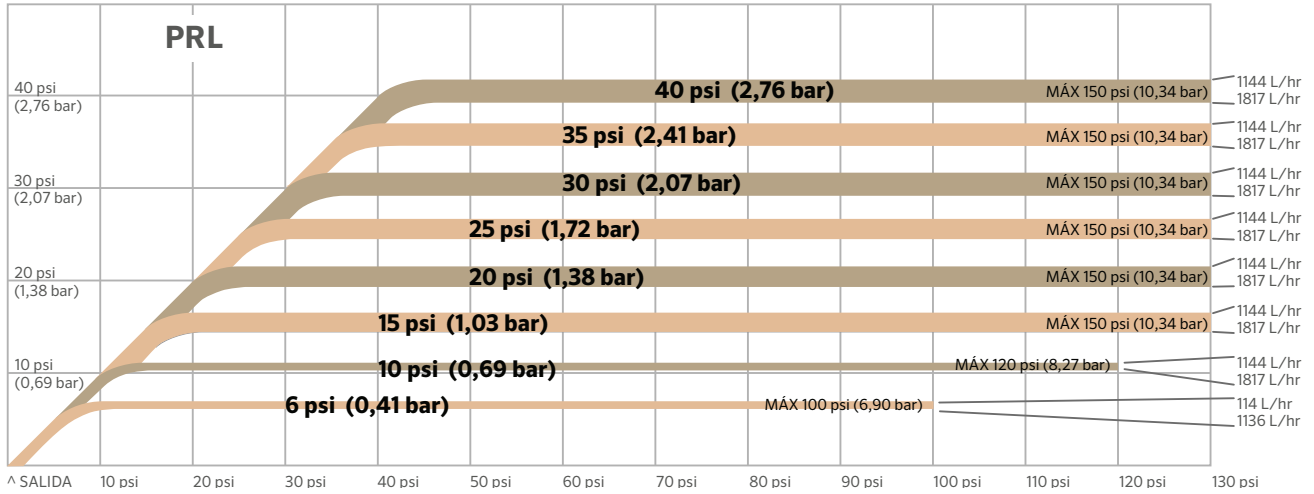

Every pressure regulator is designed to operate at a minimum and maximum inlet pressure and a predetermined flow range. This regulator performance curve illustrates how the PRL will perform within the range of inlet pressures and flows.

The Y-axis shows outlet pressure, and the X-axis shows inlet pressure.

In this chart, the band for the 30 psi (2.07 bar) model shows the performance at various flows. At the lowest flow (0.5 gpm or 114 L/hr), the regulator will maintain an actual outlet pressure slightly higher than 30 psi (2.07 bar). In contrast, at the highest flow (8 gpm or 1817 L/hr), the actual outlet pressure will be slightly lower than 30 psi (2.07 bar)\*.

\*Source: Rogers, Shaw, Pragada, & Alam, 2010.

# PMR-MF Pressure-Master Regulator® Medium Flow

Flow: 2 to 20 gpm (454 to 4543 L/hr)  
 Pressure: 6 to 60 psi (0.41 to 4.14 bar)



## FEATURES

- Maintains a constant preset outlet pressure while handling varying inlet pressures
- Inlet sizes: 3/4" NPT female, 1" NPT female, 1" NPT male, 1" BSPT female.
- Outlet sizes: 3/4" NPT female, 1" NPT female, 1" BSPT female
- Very low hysteresis and friction losses
- Pressure-tested for accuracy

PMR-MF-CMS DESIGN CRITERIA	Preset Operating Pressure	Maximum Inlet Pressure	Flow Range	
			gpm	L/hr
PMR 6 MF CMS	6 psi (0.41 bar)	80 psi (5.51 bar)	4 - 16	909 - 3634
PMR 10 MF CMS	10 psi (0.69 bar)	90 psi (6.20 bar)	4 - 16	909 - 3634
PMR 12 MF CMS	12 psi (0.83 bar)	90 psi (6.20 bar)	2 - 20	454 - 4543
PMR 15 MF CMS	15 psi (1.03 bar)	95 psi (6.55 bar)	2 - 20	454 - 4543
PMR 20 MF CMS	20 psi (1.38 bar)	100 psi (6.89 bar)	2 - 20	454 - 4543
PMR 25 MF CMS	25 psi (1.72 bar)	105 psi (7.24 bar)	2 - 20	454 - 4543
PMR 30 MF CMS	30 psi (2.07 bar)	110 psi (7.58 bar)	2 - 20	454 - 4543
PMR 35 MF CMS	35 psi (2.41 bar)	115 psi (7.93 bar)	2 - 20	454 - 4543
PMR 40 MF CMS	40 psi (2.76 bar)	120 psi (8.27 bar)	2 - 20	454 - 4543
PMR 50 MF CMS	50 psi (3.45 bar)	130 psi (8.96 bar)	2 - 20	454 - 4543
PMR 60 MF CMS	60 psi (4.14 bar)	140 psi (9.65 bar)	2 - 20	454 - 4543

Spec sheets are available online at [senninger.com](http://senninger.com)

*The pressure regulator shall maintain the predetermined pressure provided that the inlet pressure is at least 5 psi (0.34 bar) above the expected outlet pressure, but not exceeding the maximum inlet pressure as shown in this chart.*

*Pressure regulators should always be installed downstream of all shut-off valves.*

# Pressure-Master Regulator<sup>®</sup> Medium Flow **PMR-MF**

## PMR-MF Performance Curve

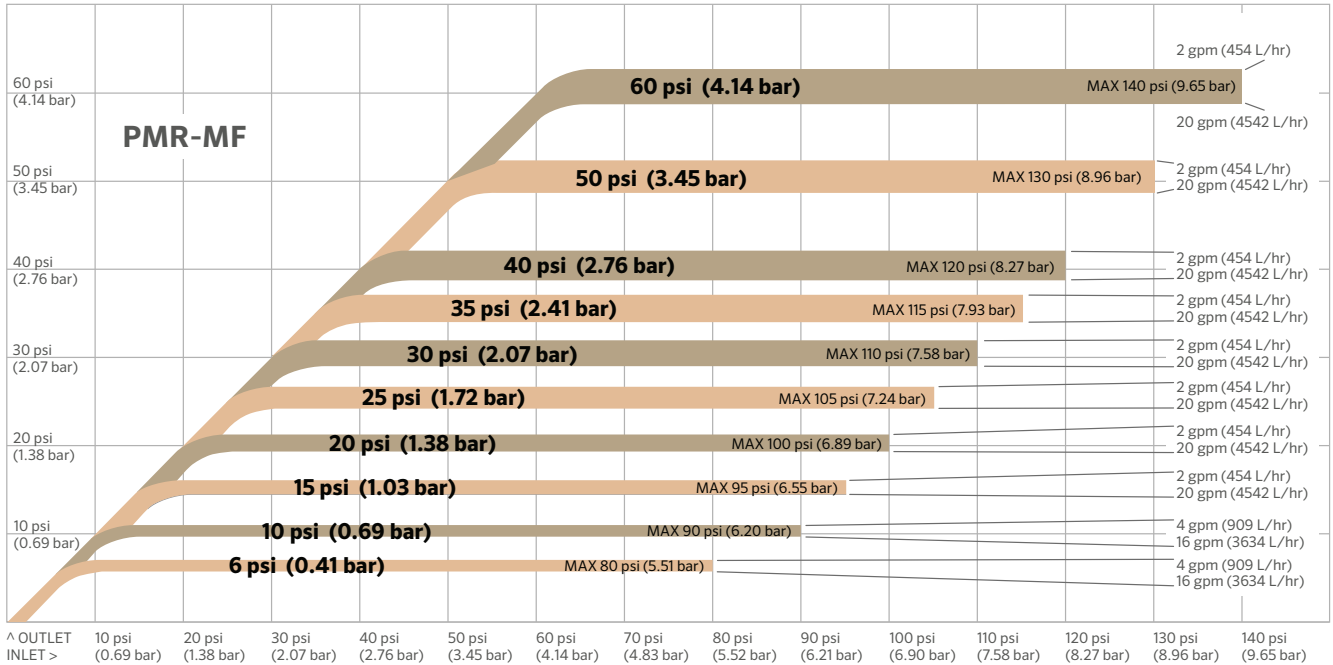

Every pressure regulator is designed to operate at a minimum and maximum inlet pressure and a predetermined flow range. This regulator performance curve illustrates how the PMR-MF will perform within the range of inlet pressures and flows.

The Y-axis shows outlet pressure, and the X-axis shows inlet pressure.

In this chart, the band for the 30 psi (2.07 bar) model shows the performance at various flows. At the lowest flow (2 gpm or 454 L/hr), the regulator will maintain an actual outlet pressure slightly higher than 30 psi (2.07 bar). In contrast, at the highest flow (20 gpm or 4542 L/hr), the actual outlet pressure will be slightly lower than 30 psi (2.07 bar)\*.

\*Source: Rogers, Shaw, Pragada, & Alam, 2010.

# PR-HF Pressure Regulator High Flow

Flow: 10 to 32 GPM (2271 to 7268 L/hr)  
 Pressure: 10 to 50 psi (0.69 to 3.45 bar)



## FEATURES

- Maintains a constant preset outlet pressure while handling varying inlet pressures
- Large flow path resists plugging
- Inlet sizes: 1 ¼" NPT female, 1 ¼" F BSPT female
- Outlet sizes: 1" NPT female, 1 ¼" NPT female, 1" BSPT female, 1 ¼" BSPT female
- Very low hysteresis and friction losses
- pH range less than 4.0
- Pressure-tested for accuracy

PR-HF DESIGN CRITERIA	Preset Operating Pressure	Maximum Inlet Pressure	Flow Range	
			gpm	L/hr
PR 10 HF	10 psi (0.69 bar)	90 psi (6.20 bar)	10 - 32	2271 - 7268
PR 15 HF	15 psi (1.03 bar)	95 psi (6.55 bar)	10 - 32	2271 - 7268
PR 20 HF	20 psi (1.38 bar)	100 psi (6.89 bar)	10 - 32	2271 - 7268
PR 25 HF	25 psi (1.72 bar)	105 psi (7.24 bar)	10 - 32	2271 - 7268
PR 30 HF	30 psi (2.07 bar)	110 psi (7.58 bar)	10 - 32	2271 - 7268
PR 40 HF	40 psi (2.76 bar)	120 psi (8.27 bar)	10 - 32	2271 - 7268
PR 50 HF	50 psi (3.45 bar)	130 psi (8.96 bar)	10 - 32	2271 - 7268

Spec sheets are available online at [senninger.com](http://senninger.com)

The pressure regulator shall maintain the predetermined pressure provided that the inlet pressure is at least 5 psi (0.34 bar) above the expected outlet pressure, but not exceeding the maximum inlet pressure as shown in this chart.

Pressure regulators should always be installed downstream of all shut-off valves.



# Pressure Regulator High Flow **PR-HF**

## PR-HF Performance Curve

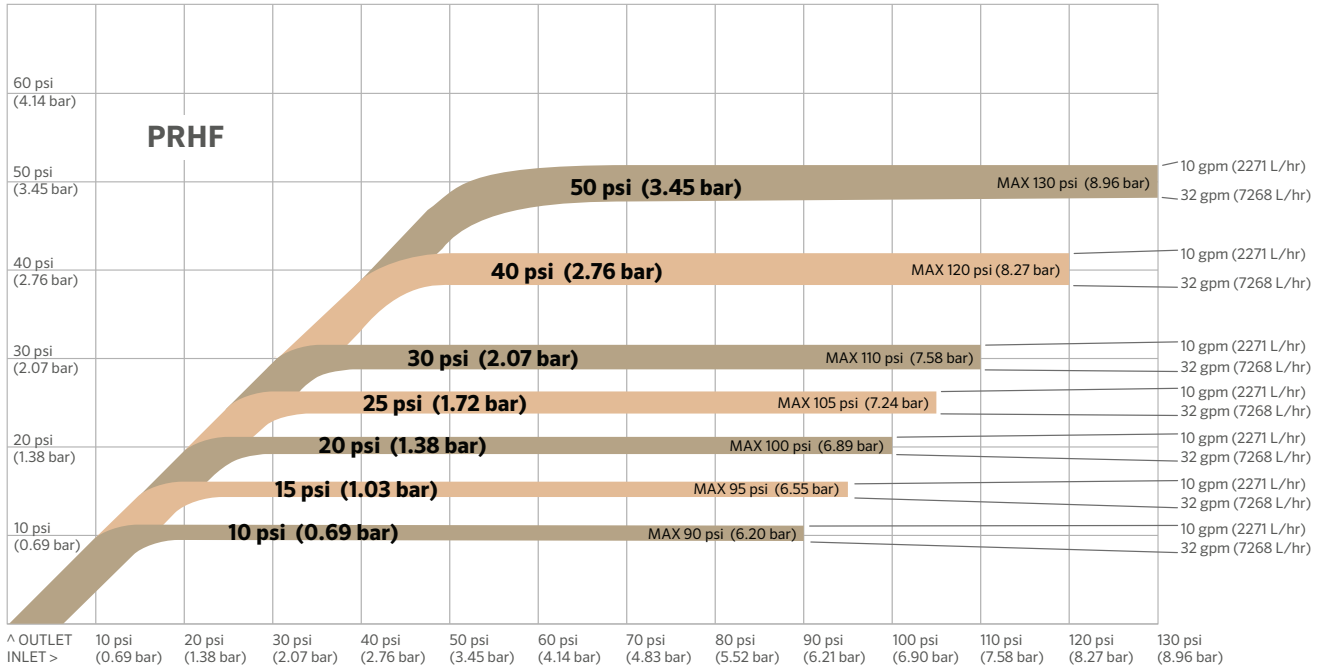

Every pressure regulator is designed to operate at a minimum and maximum inlet pressure and a predetermined flow range. This regulator performance curve illustrates how the PR-HF will perform within the range of inlet pressures and flows.

The Y-axis shows outlet pressure, and the X-axis shows inlet pressure.

In this chart, the band for the 30 psi (2.07 bar) model shows the performance at various flows. At the lowest flow (10 gpm or 2271 L/hr), the regulator will maintain an actual outlet pressure slightly higher than 30 psi (2.07 bar). In contrast, at the highest flow (32 gpm or 7268 L/hr), the actual outlet pressure will be slightly lower than 30 psi (2.07 bar)\*.

\*Source: Rogers, Shaw, Pragada, & Alam, 2010.

# PRU Pressure Regulator Ultra Flow

Flow: 20 to 100 GPM (4543 to 22713 L/hr)  
 Pressure: 10 to 60 psi (0.69 to 4.14 bar)



The PRU (Pressure Regulator Ultra) was designed to handle higher flows. Its 2" inlet and outlet size make it an ideal option for accurate zone and individual sprinkler pressure control. Its compact size fits in a valve box.



## FEATURES

- Maintains a constant preset outlet pressure while handling varying inlet pressures
- Large flow path resists plugging
- Inlet sizes: 2" NPT female, 2" BSPT female.
- Outlet sizes: 2" NPT female, 2" BSPT female
- Tamper-proof housing
- Very low hysteresis and friction losses
- Pressure-tested for accuracy
- No external metal parts for excellent corrosion resistance

PRU DESIGN CRITERIA	Preset Operating Pressure	Maximum Inlet Pressure	Flow Range	
			gpm	L/hr
PRU 10	10 psi (0.69 bar)	90 psi (6.20 bar)	20 - 100	4543 - 22713
PRU 15	15 psi (1.03 bar)	95 psi (6.55 bar)	20 - 100	4543 - 22713
PRU 20	20 psi (1.38 bar)	100 psi (6.89 bar)	20 - 100	4543 - 22713
PRU 25	25 psi (1.72 bar)	105 psi (7.24 bar)	20 - 100	4543 - 22713
PRU 30	30 psi (2.07 bar)	110 psi (7.58 bar)	20 - 100	4543 - 22713
PRU 40	40 psi (2.76 bar)	120 psi (8.27 bar)	20 - 100	4543 - 22713
PRU 50	50 psi (3.45 bar)	130 psi (8.96 bar)	20 - 100	4543 - 22713
PRU 60	60 psi (4.14 bar)	140 psi (9.65 bar)	20 - 100	4543 - 22713

Spec sheets are available online at [senninger.com](http://senninger.com)

The pressure regulator shall maintain the predetermined pressure provided that the inlet pressure is at least 5 psi (0.34 bar) above the expected outlet pressure, but not exceeding the maximum inlet pressure as shown in this chart.

Pressure regulators should always be installed downstream of all shut-off valves.

# Pressure Regulator Ultra Flow **PRU**

## PRU Performance Curve

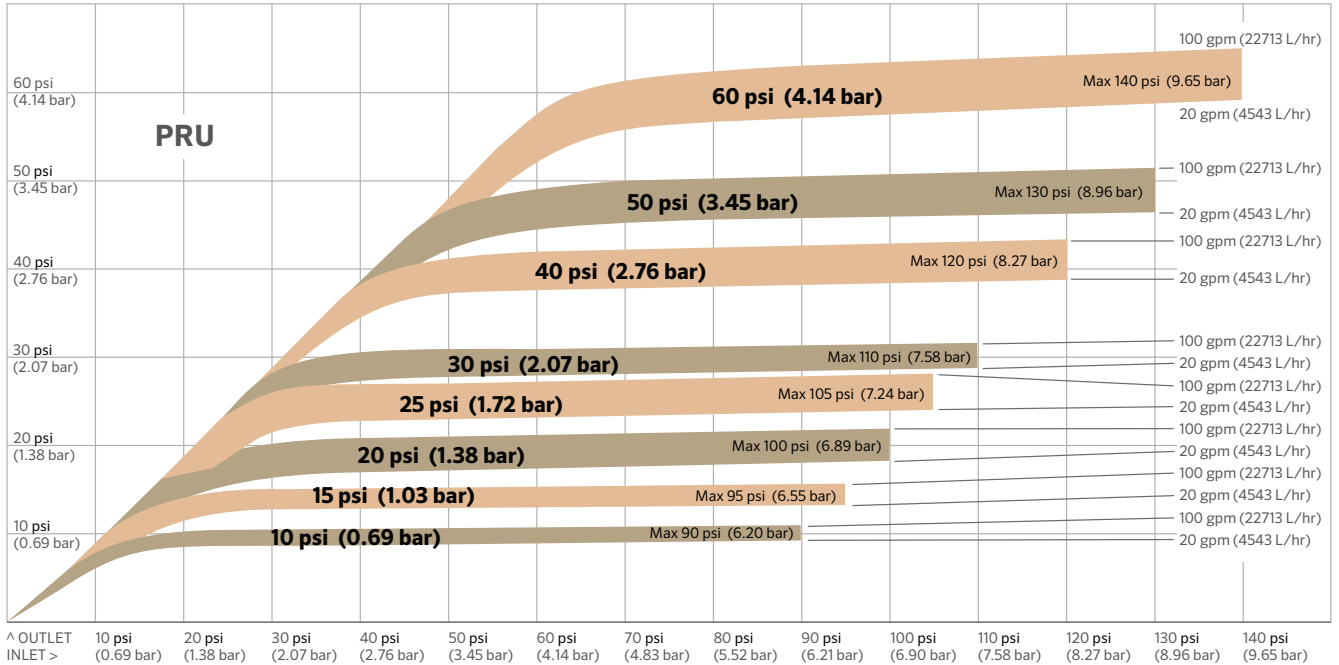

Every pressure regulator is designed to operate at a minimum and maximum inlet pressure and a predetermined flow range. This regulator performance curve illustrates how the PRU will perform within the range of inlet pressures and flows.

The Y-axis shows outlet pressure, and the X-axis shows inlet pressure.

In this chart, the band for the 30 psi (2.07 bar) model shows the performance at various flows. At the lowest flow (20 gpm or 4543 L/hr), the regulator will maintain an actual outlet pressure slightly higher than 30 psi (2.07 bar). In contrast, at the highest flow (100 gpm or 22713 L/hr), the actual outlet pressure will be slightly lower than 30 psi (2.07 bar)\*.

\*Source: Rogers, Shaw, Pragada, & Alam, 2010.

# PRLV Pressure Regulator Limit Valve

Flow: Up to 18 gpm (4088 L/hr)  
 Pressure: 10 to 60 psi (0.69 to 4.14 bar)

Pressure Regulating Limit Valves are designed to be used in place of standard pressure regulators to limit static (no flow) water pressure when a shut-off valve is used downstream from the regulation point. This limits downstream pressure and protects downstream components.

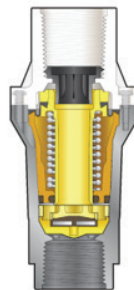

Cutaway of a PRLV limit valve

## FEATURES

- Maintains a constant preset outlet pressure while handling varying inlet pressures
- Limits downstream pressure to no more than 15 psi (1.03 bar) above regulated pressure rating during static (no flow) conditions
- Inlet sizes: 3/4" NPT female, 1" NPT female, 1" NPT male, 1" BSPT female.
- Outlet sizes: 3/4" NPT female, 1" NPT female, 1" BSPT female.
- 100% pressure tested for accuracy
- Very low hysteresis and friction losses

PRLV DESIGN CRITERIA LIMIT VALVE	Preset Operating Pressure	Maximum Inlet Pressure	Maximum Flow		Inlet Sizes	Outlet Sizes
			gpm	L/hr		
PRLV 10	10 psi (0.69 bar)	125 psi (8.62 bar)	18	4088	¾" F NPT, 1" F NPT	¾" F NPT, 1" F NPT
PRLV 15	15 psi (1.03 bar)	125 psi (8.62 bar)	18	4088	¾" F NPT, 1" F NPT	¾" F NPT, 1" F NPT
PRLV 20	20 psi (1.38 bar)	125 psi (8.62 bar)	18	4088	¾" F NPT, 1" F NPT	¾" F NPT, 1" F NPT
PRLV 30	30 psi (2.07 bar)	125 psi (8.62 bar)	18	4088	¾" F NPT, 1" F NPT	¾" F NPT, 1" F NPT
PRLV 40	40 psi (2.76 bar)	125 psi (8.62 bar)	18	4088	¾" F NPT, 1" F NPT	¾" F NPT, 1" F NPT
PRLV 50	50 psi (3.45 bar)	125 psi (8.62 bar)	18	4088	¾" F NPT, 1" F NPT	¾" F NPT, 1" F NPT
PRLV 60	60 psi (4.14 bar)	125 psi (8.62 bar)	18	4088	¾" F NPT, 1" F NPT	¾" F NPT, 1" F NPT

The pressure regulator shall maintain the predetermined operating pressure provided that the inlet pressure is at least 5 psi (0.34 bar) above the expected outlet pressure, but not exceeding the maximum inlet pressure as shown above.

Recommended for outdoor use only. Not NSF certified.

# Pressure Regulator Limit Valve **PRLV**

## PRLV Performance Curve

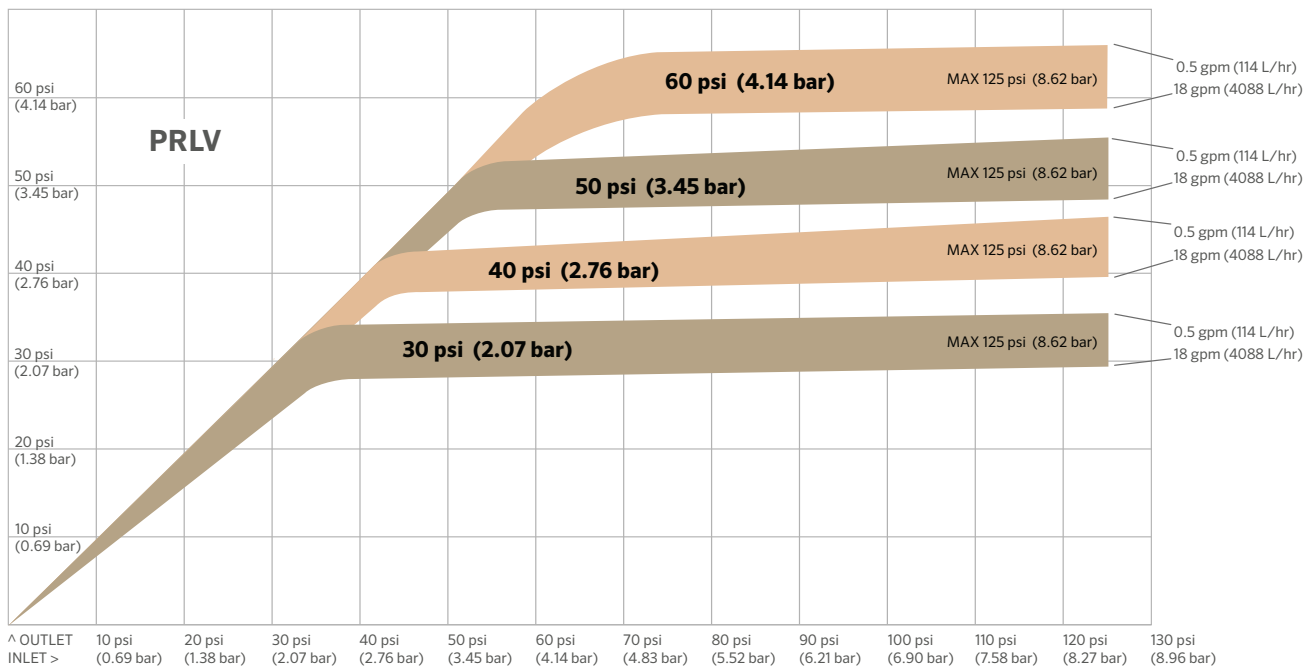

Every pressure regulator is designed to operate at a minimum and maximum inlet pressure and a predetermined flow range. This regulator performance curve illustrates how the PRLV will perform within the range of inlet pressures and flows.

The Y-axis shows outlet pressure, and the X-axis shows inlet pressure.

In this chart, the band for the 30 psi (2.07 bar) model shows the performance at various flows. At the lowest flow (0.5 gpm or 114 L/hr), the regulator will maintain an actual outlet pressure slightly higher than 30 psi (2.07 bar). In contrast, at the highest flow (18 gpm or 4088 L/hr), the actual outlet pressure will be slightly lower than 30 psi (2.07 bar)\*.

\*Source: Rogers, Shaw, Pragada, & Alam, 2010.

# PRXF-LV Pressure Regulator Limit Valve

Flow: Up to 75 gpm (17034 L/hr)  
 Pressure: 20 to 60 psi (1.38 to 4.14 bar)



The PRXF-LV was designed to handle flows up to 75 gpm (17034 L/hr). Pressure Regulating Limit Valves are designed to be used in place of standard pressure regulators to limit static (no flow) water pressure when a shut-off valve is used downstream from the regulation point. This limits downstream pressure and protects downstream components.

### INSTALLATION GUIDELINES

- Never allow solvent or cement to drip into regulator.
- Make sure the flow arrows on the regulator match the direction of the system flow.
- Installation of a union is recommended for easy removal of PRXF-LV.

### FEATURES

- Maintains a constant preset outlet pressure with varying inlet pressures, which alleviates pressure differences that can cause an applicator's area of coverage to change.
- Limits downstream pressure to no more than 15 psi (1.03 bar) above regulated pressure rating during static (no flow) conditions
- Inlet size: 3" slip female
- Outlet size: 3" slip female
- Pressure tested for accuracy
- Very low hysteresis and friction losses

PRXF-LV DESIGN CRITERIA	Preset Operating Pressure	Maximum Inlet Pressure	Maximum Flow		Inlet Sizes	Outlet Sizes
			gpm	L/hr		
PRXF 20 LV	20 psi (1.38 bar)	125 psi (8.62 bar)	75	17034	3" F slip	3" F slip
PRXF 30 LV	30 psi (2.07 bar)	125 psi (8.62 bar)	75	17034	3" F slip	3" F slip
PRXF 40 LV	40 psi (2.76 bar)	125 psi (8.62 bar)	75	17034	3" F slip	3" F slip
PRXF 50 LV	50 psi (3.45 bar)	125 psi (8.62 bar)	75	17034	3" F slip	3" F slip
PRXF 60 LV	60 psi (4.14 bar)	125 psi (8.62 bar)	75	17034	3" F slip	3" F slip

The pressure regulator shall maintain the predetermined operating pressure provided that the inlet pressure is at least 5 psi (0.34 bar) above the expected outlet pressure, but not exceeding the maximum inlet pressure as shown above.

Recommended for outdoor use only. Not NSF certified.

# Pressure Regulator Limit Valve **PRXF-LV**

## PRXF-LV Performance Curve

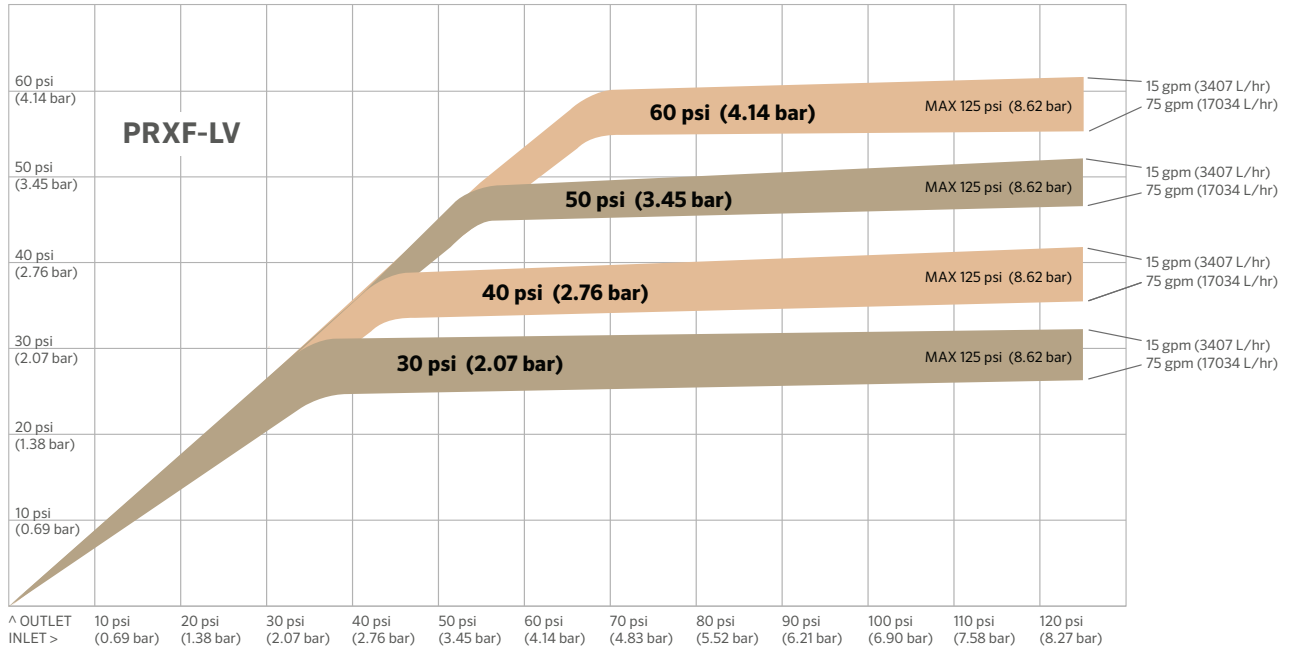

Every pressure regulator is designed to operate at a minimum and maximum inlet pressure and a predetermined flow range. This regulator performance curve illustrates how the PRXF-LV will perform within the range of inlet pressures and flows.

The Y-axis shows outlet pressure, and the X-axis shows inlet pressure.

In this chart, the band for the 30 psi (2.07 bar) model shows the performance at various flows. At the lowest flow (15 gpm or 3407 L/hr), the regulator will maintain an actual outlet pressure slightly higher than 30 psi (2.07 bar). In contrast, at the highest flow (75 gpm or 17034 L/hr), the actual outlet pressure will be slightly lower than 30 psi (2.07 bar)\*.

\*Source: Rogers, Shaw, Pragada, & Alam, 2010.

# Riser Adapter

Senninger Riser Adapter Assemblies make setting up irrigation systems easy. They allow specific sprinkler placement as recommended for optimum distribution with tubing connecting each to the closest lateral. They also allow the flexibility of relocating a sprinkler without disrupting its connection to the lateral.

**LOWER FLOWS** (Use with 0.270" I.D. tubing)

**Riser Adapter Assembly  
RSASM23C3**

**Riser Adapter:**  
RAD270  
1/2" F NPT x  
0.270"

**Tubing:**  
TU1ST3  
0.270"  
(three feet)

**Fitting:**  
FTA1B1B  
0.270" Super Barb  
x Hose Barb  
Insert Adapter

**Riser Adapter Assembly  
Quick-Connect  
RSASM2TC3QCA2T**

**Riser Adapter  
Quick-Connect:**  
RSAD2T  
1/2" F NPT x 0.270"

**Tubing:**  
TU1ST3  
0.270" (three feet)

**Fitting:**  
FTA1B2T  
0.270" Super barb  
x #2 taper

**Bushing:**  
FTHS2T  
Winged Hose Barb  
#2 Taper

**HIGHER FLOWS** (Use with 0.345" I.D. tubing)

**Riser Adapter Assembly  
RSASM24C3**

**Riser Adapter:**  
RSAD345  
1/2" F NPT x  
0.345"

**Tubing:**  
TU15ST  
0.345"  
(three feet)

**Fitting:**  
FTA15B15B  
0.345" Super Barb  
x Hose Barb  
Insert Adapter

**Riser Adapter Assembly  
Quick-Connect  
RSASM24C3QCA2T**

**Riser Adapter  
Quick-Connect:**  
RSAD345  
1/2" F NPT x 0.345"

**Tubing:**  
TU15ST  
0.345" (three feet)







**Fitting:**  
FTA15B2T  
0.345" Super barb  
x #2 taper

**Bushing:**  
FTHS2T  
Winged Hose Barb  
#2 Taper

Also available with 3T Taper  
connection - RSASM24C3QCA3T

All four assemblies are available with other precut tubing lengths. Contact factory.



**FITTINGS & BUSHINGS**

-  **FTHS2T** - Fitting Winged Hose Barb Bushing for #2 Taper
-  **FTHS3T** - Fitting Winged Hose Barb Bushing for #3 Taper
-  **FT4HSC2T** - Fitting Barb Bushing Clamp for 1" Hose and #2 Taper
-  **FT1M2T** - Fitting Winged 1/4" M NPT Threaded Bushing for #2 Taper
-  **FTPLUG2T** - Fitting Plug with #2 Taper (red)
-  **FTPLUG3T** - Fitting Plug with #3 Taper (maroon)

**RISER STAKES**

-  **RSST26** - Riser Stake 26" with connection for Tubing or Riser Adapter
  -  **RSST14** - Riser Stake 14" with connection for Tubing or Riser Adapter
- The assemblies can be mounted on 1/2" PVC risers or the Senninger 26" or 14" Riser Stakes.

**TUBING PUNCH TOOLS**

-  **TUPTAP4I** - Tubing Punch Tool for use with FTA1B1B (green handle)
-  **TUPTAP5I** - Tubing Punch Tool for use with FTA15B15B, FTHS2T, FTHS3T, FT1M2T, and FT4HSC2T (red handle)



# Quick-Connect Coupling



The Quick-Connect Coupling provides installation versatility. It can be used along the lateral to make it easy to disassemble in manageable sections. It can also be installed on the riser to allow easy removal of the sprinkler.



TWO-PIECE HOUSING THAT LOCKS TIGHTLY

**FEATURES:**

- Lightweight for easy portability
- Virtually leak-proof connection
- Four Models: 1-inch, 1 1/4-inch, 32 mm and 40 mm
- Constructed out of UV resistant thermoplastics

## Installation Options

**DESIGN CRITERIA**

Pipe Diameter	Maximum Pressure	Part Number
1 inch	100 psi (7.0 bar)	QCPLASM4
1 1/4 inch	100 psi (7.0 bar)	QCPLASM5
32 mm	100 psi (7.0 bar)	QCPLASM32MM
40 mm	100 psi (7.0 bar)	QCPLASM40MM

**ATTACHING THE QUICK-CONNECT COUPLING**

Apply glue to the outside of the pipe before inserting upper or lower housings. Once glue is dry, connect housings together by inserting the button on the lower housing into the tabbed area of the upper housing. Twist to lock.

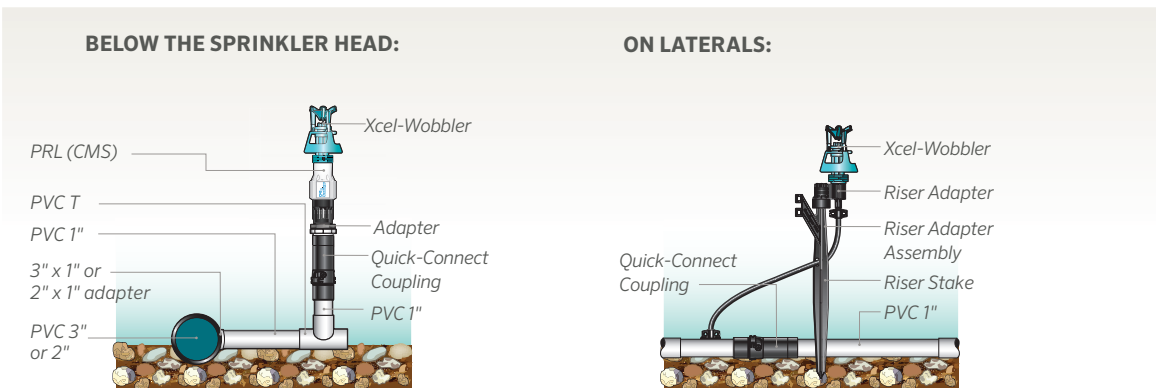

# WinSIPP™ 3 Custom Mining Software

The Senninger WinSIPP3 software provides a visual comparison to help analyze various mining leaching installations. It compares different sprinklers, spacings, heights, operating pressures, and nozzle sizes to calculate the application rate and uniformity.

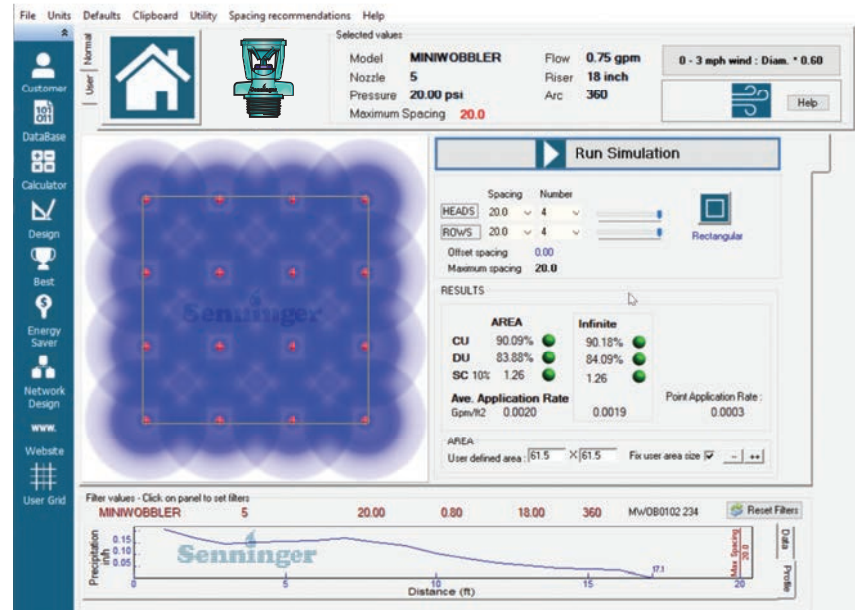

This installation has a CU of 90% and a DU of 84%. The SC is about 1.3, and the Average Application Rate is 0.002 gpm (0.43 L/hr).

The densogram shows the overlap of multiple sprinklers. In this example, a mini-Wobbler™ sprinkler with a #5 nozzle operating at 20 psi (1.38 bar) and installed on an 18" (46 cm) riser, at 20 x 20 ft (6 x 6 m) spacing.



Scan the QR code for more information about WinSIPP3.

# Custom Mining Software **WinSipp™ 3**

WinSIPP3 Mining Software allows designing a leaching pad from the selected sprinkler, obtaining as a result pressures in the sprinklers and valves, as well as the selection of pipe diameters based on flow velocities.

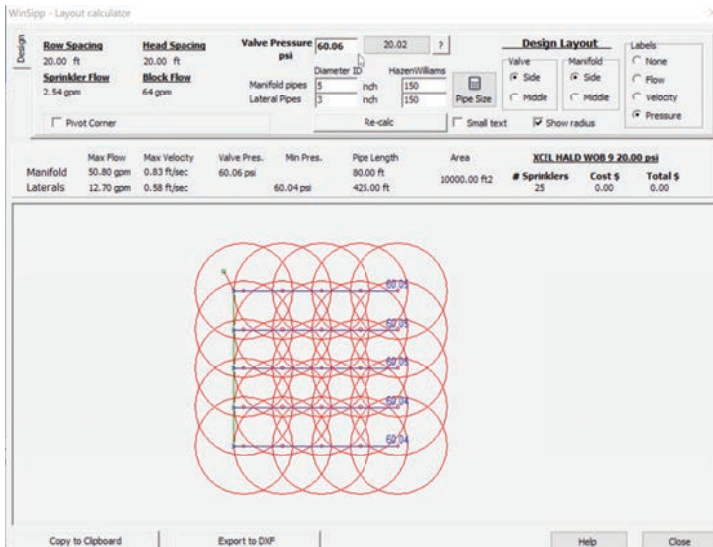

## FEATURES

- Aids in the selection of the best sprinklers for each installation
- Tests the application uniformity of sprinkler layouts before the system is installed
- Compares different sprinklers, models, operating pressure, nozzle size/flow, riser height, spacing, layout, and area
- Illustrates the uniformity of overlapping sprinklers and the individual sprinkler profile for each scenario
- Calculates the application rate and scheduling coefficient for each set of parameters



The sprinkler profiles show the amount of water delivered at various intervals and the sprinkler’s radius of throw.

In this example, the radius of the Xcel-Wobbler is shown at three different nozzle sizes (#9, 10, and 14), with the sprinkler installed on an 18-inch (46 cm) riser and operating at 20 psi (1.38 bar). The flow and radius of throw change based on nozzle size.

# Irri-Maker™

Irrimaker lets you design comprehensive irrigation projects ranging from large- to small-scale. It lets you evaluate installation alternatives in advance, survey any terrain, produce a contour plan, draw the details, produce a bill of materials, and send drawing results back to AutoCAD and Google Maps.

Irri-Maker has built-in CAD module that allows adding specific details to the contour plan like roads, fences, boundaries, and rivers, including text and bitmap images. This software also operates within the larger Model Maker™ environment, which means, any of the other Model Maker modules can be added.

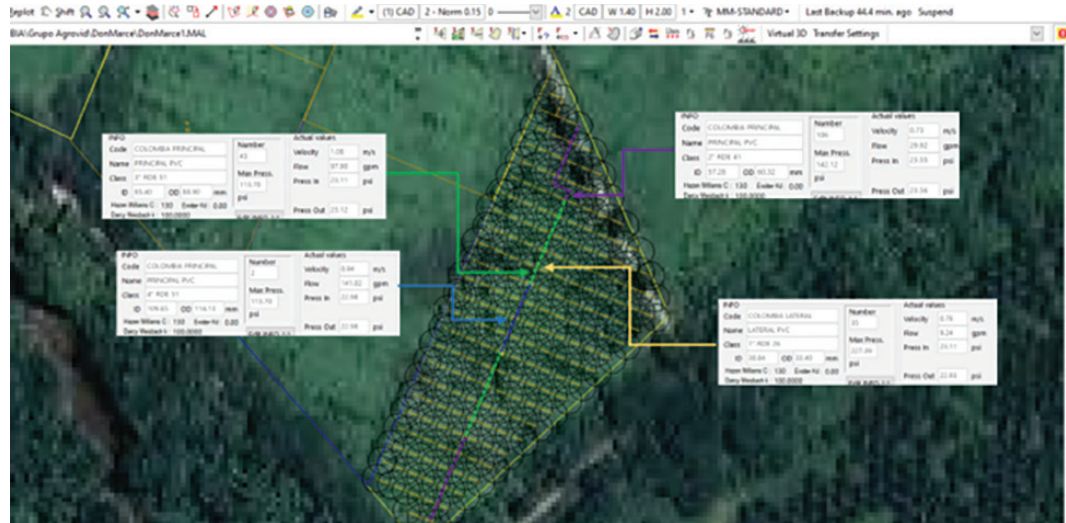
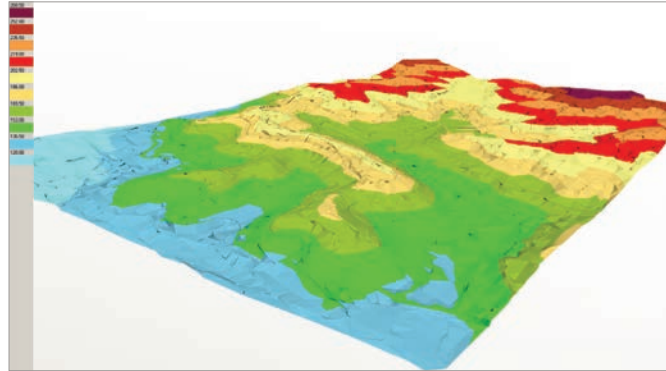

Scan the QR code for more information about Irri-Maker.

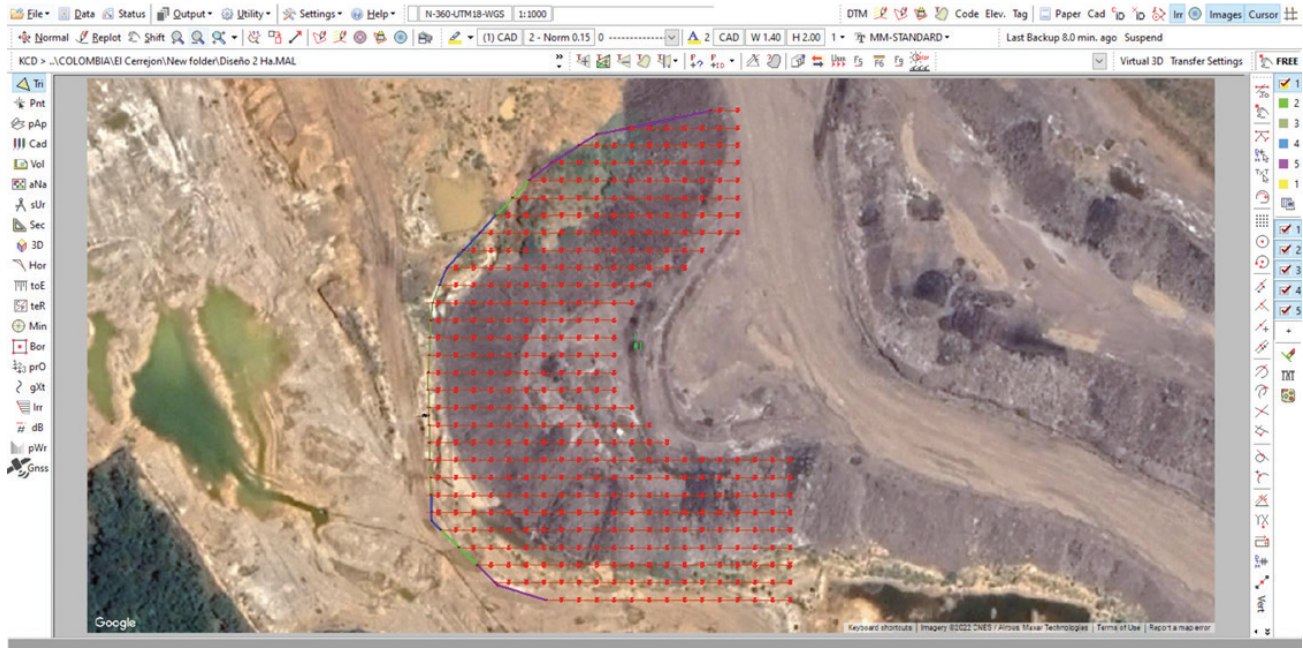

## FEATURES

- All in one software package: combines surveyed data, CAD, Digital Terrain Modeling (DTM) and irrigation calculation functions
- Generates contour plans and 3D images illustrating the irrigation design in relation to slopes and elevations
- Calculate hydraulics, pressures, flows and quantities
- Full graphical control over each element of the design, including block areas, sprinklers, and pipes
- Saves time on repeatable routines
- Allows importation of information from many other programs

## ADVANTAGES

### GET MORE INSIGHTS FROM YOUR DESIGN

Get precise measurements, a complete bill of materials, and peace of mind with every design project.

### DATA ENTRY

Enter data with manual surveys, or import your data from GPS collection easily

### MODELING

Quickly create a surface model that you have complete control over.

### DRAFTING

Produce fast and effective layouts, calculate hydraulics, size pipes and more with our CAD solution.

# Nozzles

Senninger offer a variety of nozzle sizes to customize sprinklers for peak performance.

## FEATURES

- Color-coded for easy size identification
- Excellent durability

Nozzle # Nozzle color	Nozzle Size US	Nozzle Size Metric
#4 Light Blue	1/16"	1.59 mm
#4.5 Light Blue	9/128"	1.78 mm
#5 Beige	5/64"	1.98 mm
#5.5 Beige	11/128"	2.16 mm
#6 Gold	3/32"	2.38 mm
#6.5 Gold	13/128"	2.59 mm
#7 Lime	7/64"	2.78 mm
#7.5 Lime	15/128"	2.97 mm
#8 Lavender	1/8"	3.18 mm
#8.5 Lavender	17/128"	3.38 mm
#9 Grey	9/64"	3.57 mm
#9.5 Grey	19/128"	3.76 mm
#10 Turquoise	5/32"	3.97 mm
#10.5 Turquoise	21/128"	4.17 mm
#11 Yellow	11/64"	4.37 mm
#11.5 Yellow	23/128"	4.57 mm
#12 Red	3/16"	4.76 mm
#12.5 Red	25/128"	4.95 mm
#13 White	13/64"	5.16 mm
#13.5 White	27/128"	5.36 mm
#14 Blue	7/32"	5.56 mm
#14.5 Blue	29/128"	5.77 mm
#15 Dark Brown	15/64"	5.95 mm
#15.5 Dark Brown	31/128"	6.15 mm
#16 Orange	1/4"	6.35 mm
#16.5 Orange	33/128"	6.55 mm
#17 Dark Green	17/64"	6.75 mm
#17.5 Dark Green	35/128"	6.93 mm
#18 Purple	9/32"	7.14 mm
#18.5 Purple	37/128"	7.34 mm
#19 Black	19/64"	7.54 mm
#19.5 Black	39/128"	7.75 mm
#20 Dark Turquoise	5/16"	7.94 mm
#20.5 Dark Turquoise	41/128"	8.13 mm
#21 Mustard	21/64"	8.33 mm
#21.5 Mustard	43/128"	8.53 mm
#22 Maroon	11/32"	8.73 mm
#22.5 Maroon	45/128"	8.94 mm
#23 Cream	23/64"	9.13 mm
#23.5 Cream	47/128"	9.32 mm
#24 Dark Blue	3/8"	9.53 mm
#24.5 Dark Blue	49/128"	9.73 mm
#25 Copper	25/64"	9.92 mm
#25.5 Copper	51/128"	10.11 mm
#26 Bronze	13/32"	10.32 mm

# Product Warranty

## WARRANTY & DISCLAIMER

This warranty supersedes all other warranties expressed or implied. No person has the authority to incur or assume for Senninger Irrigation, Inc. ("Senninger") any other liability as to the products manufactured by Senninger.

This warranty does not extend to any product or part that has been repaired, altered, or modified in any way outside the Senninger factory, nor shall it apply to any product which has been subject to misuse, negligence or accident, or improper operation contrary to Senninger's published instructions. Under no circumstances will Senninger be held responsible or liable for any consequential, incidental or punitive damages resulting from the use of Senninger products, or resulting from any product defects, failure or malfunction.

This warranty extends only to the original purchaser of the Senninger product. This warranty does not extend to any product or part manufactured by others.

## MATERIALS AND WORKMANSHIP

Products manufactured by Senninger for use in mining applications are warranted to be free of defects in materials or workmanship under normal use for a period of one (1) year from the date of manufacture.

## PERFORMANCE

Products manufactured by Senninger for use in mining applications are warranted to maintain their original performance for a period of one (1) year from the date of manufacture if installed and operated in accordance with Senninger's published specifications and used as intended for irrigation purposes.

## REPAIR OR REPLACEMENT

If a Senninger product is suspected of failure during the applicable warranty period, Senninger will repair or replace, at its option, the product or the defective part. Contact Senninger customer service in Clermont, Florida USA for specific instructions on how to proceed with a warranty claim. If after inspection of the product and documentation the failure is deemed a warranty issue, a replacement or credit will be authorized. Senninger is not obligated to pay for repairs or replacements made by anyone other than itself. No labor allowances will be made for removal or replacement of warranted parts nor for any travel to and from the product to make said repairs or replacement without prior written authorization from Senninger.

## SUITABILITY

There are no other warranties, expressed or implied, including warranties of merchantability and warranties of fitness for a particular purpose. It is the sole responsibility of the purchaser to consider and analyze the product and its design to be suitable for specific applications.



The Senninger commitment to world-class products, local support and technical expertise ensure we provide the most efficient and reliable water application solutions available in the world today.

A handwritten signature in white ink, reading "SD Abernethy".

Stephen D. Abernethy, President of Senninger Irrigation