

Senninger® Solid Set / Nursery Irrigation Products

Low Pressure - High Performance™

Hunter®

Agricultural Irrigation



WHAT'S INSIDE

WOBBLER

■ mini-Wobbler™ Upright	04
■ mini-Wobbler™ Inverted	05
■ Xcel-Wobbler™	06
■ Wobbler®	08

NON-IMPACT

■ Smooth Drive™	10
-----------------	----

MICRO SPRINKLERS

■ Fogger	11
■ Mister™ Upright	12
■ Mister™ Inverted	13
■ Micro-Sprinkler Upright	14
■ Micro-Sprinkler Inverted	15

SPRAYS

■ Spray Stake	16
■ T-Spray™	17
■ Triad™	18
■ Super Spray®	19

IMPACT SPRINKLERS

■ 20 Series	20
■ Compact Impact	22
■ WedgeDrive™	23
■ 30 Series	24
■ 40 Series	26
■ 50 Series	28
■ Part-Circle	30
■ 70 Series	32
■ 80 Series	34

COMPONENTS

■ Riser Adapter Assemblies	36
■ Drop Adapter Assemblies	37
■ Drain Stop Plus™	38
■ Fittings & Couplings	38
■ Quick-Connect Coupling	39

PRESSURE REGULATORS

■ Regulator Comparisons	41
NEW! ■ MPR - Mini	42
■ PRLG - Landscape Grade	43
■ PRL - Low Flow	44
■ PSR™2	45
NEW! ■ Filter Regulator	46
■ PMR-MF - Medium Flow	48
■ PR-HF - High Flow	49
■ PRU - Ultra High Flow	50
■ PRLV	51
■ PRXF-LV	52

SOFTWARE

■ Irrimaker/IrriExpress	53
■ WinSIPP™3	54

RESOURCES

■ Formulas & Conversions	55
■ Precipitation Rates- US	56
■ Precipitation Rates- Metric	57
■ Nozzles	58
■ Product Warranty	59



PARTNERING TOGETHER

“Guaranteed Performance”

For over 6 decades, Senninger® has been the proud provider of agricultural irrigation products serving farmers and irrigation professionals around the world. To further strengthen our company, Senninger Irrigation will now proudly carry the family name of our parent company, as Hunter Agricultural Irrigation.

What This Means to You:

- Continued high-quality Senninger products
- Growing footprint of facilities and personnel to meet your irrigation needs
- Continued outstanding technical support and customer service
- Enhanced production and automation investments worldwide
- Long term commitment to the agricultural irrigation markets we serve

We're grateful to you, our customers, for your partnership and trust over the years. Your support continues to drive our passion for providing industry-leading products, comprehensive educational programs, and exceptional customer service.

mini-Wobbler™ Upright



The mini-Wobbler™ uses the Senninger® Wobbler® Technology off-center rotary-action. It provides extremely uniform coverage over a large diameter at low pressures.



FEATURES

- Low evaporative loss
- Multi-level throw: 10°
- Flow rates: 0.42 to 2.18 gpm (95 to 495 L/hr)
- Operating pressures: 15 to 25 psi (1.03 to 1.72 bar)
- Connection: 1/2" male NPT

SPRINKLER INLET PRESSURE-US

	psi			SPRINKLER INLET PRESSURE-METRIC	bar		
	15	20	25		1.03	1.38	1.72
#4 Nozzle - Light Blue (1/16")				#4 Nozzle - Light Blue (1.59 mm)			
Flow (gpm)	0.42	0.50	0.56	Flow (L/hr)	95	114	127
Diameter at 1.5 ft ht (ft)	26.5	28.0	28.0	Diameter at 0.46 m ht (m)	8.1	8.5	8.8
Diameter at 3.0 ft ht (ft)	31.0	32.0	34.0	Diameter at 0.91 m ht (m)	9.5	9.8	10.1
#5 Nozzle - Beige (5/64")				#5 Nozzle - Beige (1.98 mm)			
Flow (gpm)	0.64	0.75	0.84	Flow (L/hr)	145	170	191
Diameter at 1.5 ft ht (ft)	31.0	33.5	35.0	Diameter at 0.46 m ht (m)	9.5	10.2	10.7
Diameter at 3.0 ft ht (ft)	36.5	39.0	39.5	Diameter at 0.91 m ht (m)	11.1	11.9	12.0
#6 Nozzle - Gold (3/32")				#6 Nozzle - Gold (2.38 mm)			
Flow (gpm)	0.95	1.10	1.25	Flow (L/hr)	216	250	284
Diameter at 1.5 ft ht (ft)	33.0	36.0	37.0	Diameter at 0.46 m ht (m)	10.1	11.0	11.3
Diameter at 3.0 ft ht (ft)	39.5	42.0	42.0	Diameter at 0.91 m ht (m)	12.0	12.8	12.8
#7 Nozzle - Lime (7/64")				#7 Nozzle - Lime (2.78 mm)			
Flow (gpm)	1.30	1.51	1.69	Flow (L/hr)	295	343	384
Diameter at 1.5 ft ht (ft)	35.0	37.5	38.5	Diameter at 0.46 m ht (m)	10.7	11.4	11.7
Diameter at 3.0 ft ht (ft)	41.0	43.0	43.0	Diameter at 0.91 m ht (m)	12.5	13.1	13.1
#8 Nozzle - Lavender (1/8")				#8 Nozzle - Lavender (3.18 mm)			
Flow (gpm)	1.67	1.95	2.18	Flow (L/hr)	379	443	495
Diameter at 1.5 ft ht (ft)	35.5	38.5	39.0	Diameter at 0.46 m ht (m)	10.8	11.7	11.9
Diameter at 3.0 ft ht (ft)	41.5	43.0	43.0	Diameter at 0.91 m ht (m)	12.7	13.1	13.3

Also available with #9 and #10 nozzle. Consult factory for specific performance data. Sprinkler performance may vary with actual field conditions. Upright model stream heights range from 1.5 to 3.0 ft (0.46 to 0.91 m) above the nozzle based on pressure and nozzle size. Minimum recommended riser height is 1.5 ft (0.46 m).

RISER ADAPTER

The mini-Wobbler can be mounted on the Riser Adapter Assembly for installation versatility. (See page 36)



RISER STAKE

The mini-Wobbler can be mounted on the 26" Riser Stake with the Riser Adapter for installation versatility. (See page 36)



Inverted **i-mini-Wobbler™**

The i-mini-Wobbler™ uses the Senninger® Wobbler® Technology off-center rotary-action. It is designed for inverted installations in greenhouses and it produces a broad rain-like application.



FEATURES

- Low evaporative loss
- Multi-level throw: 0°
- Flow rates: 0.75 to 2.18 gpm (170 to 495 L/hr)
- Operating pressures: 20 to 25 psi (1.38 to 1.72 bar)
- Connection: 1/2" male NPT

DROP ADAPTER

Mount the Inverted mini-Wobbler on one of the Drop Adapter Assemblies. (See page 37)



DRAIN STOP PLUS™

Use the Senninger® Drain Stop Plus with the i-mini-Wobbler. It is specifically designed for overhead irrigation to prevent drainage from sprinklers when the system is shut down. (See page 38)



SPRINKLER INLET PRESSURE-US	psi		SPRINKLER INLET PRESSURE-METRIC	bar	
	20	25		1.38	1.72
#5 Nozzle - Beige (5/64")			#5 Nozzle - Beige (1.98 mm)		
Flow (gpm)	0.75	0.84	Flow (L/hr)	170	191
Diameter at 3.0 ft ht (ft)	30.0	31.0	Diameter at 0.91 m ht (m)	9.2	9.5
Diameter at 6.0 ft ht (ft)	32.0	32.5	Diameter at 1.83 m ht (m)	9.8	9.9
#6 Nozzle - Gold (3/32")			#6 Nozzle - Gold (2.38 mm)		
Flow (gpm)	1.10	1.25	Flow (L/hr)	250	284
Diameter at 3.0 ft ht (ft)	31.0	31.4	Diameter at 0.91 m ht (m)	9.5	9.6
Diameter at 6.0 ft ht (ft)	34.0	34.5	Diameter at 1.83 m ht (m)	10.4	10.5
#7 Nozzle - Lime (7/64")			#7 Nozzle - Lime (2.78 mm)		
Flow (gpm)	1.51	1.69	Flow (L/hr)	343	384
Diameter at 3.0 ft ht (ft)	31.0	32.0	Diameter at 0.91 m ht (m)	9.5	9.8
Diameter at 6.0 ft ht (ft)	35.0	35.5	Diameter at 1.83 m ht (m)	10.7	10.8
#8 Nozzle - Lavender (1/8")			#8 Nozzle - Lavender (3.18 mm)		
Flow (gpm)	1.95	2.18	Flow (L/hr)	443	495
Diameter at 3.0 ft ht (ft)	31.5	32.0	Diameter at 0.91 m ht (m)	9.6	9.8
Diameter at 6.0 ft ht (ft)	35.5	36.0	Diameter at 1.83 m ht (m)	10.8	11.0

Sprinkler performance may vary with actual field conditions. Inverted model stream heights range from 0.5 to 1.5 ft (0.2 to 0.46 m) above nozzle based on pressure and nozzle size.

Xcel-Wobbler™ Mid & High Angle

The Xcel-Wobbler™ uses the Senninger® Wobbler® Technology off-center rotary-action. It provides an extremely uniform and instantaneous application pattern over a large area at lower pressures, and with very low evaporative loss.



MID-ANGLE



HIGH-ANGLE

FEATURES

- Counter-balance reduces vibration for a smooth, stable performance
- Only one moving part - which translates to longer life
- Connections: 3/4" or 1/2" male NPT
- Flow rates: 0.78 to 6.97 gpm (177 to 1583 L/hr)
- Operating pressures: 10 to 25 psi (0.69 to 1.72 bar)
- Low wind drift and evaporative loss at low pressures

OVERHEAD COMPARISON OF SPRINKLER DISTRIBUTION PATTERNS



The Xcel-Wobbler has a larger area of instantaneous application which protects the soil structure, helping to maintain infiltration capability.

Mid & High Angle Xcel-Wobbler™

SPRINKLER INLET PRESSURE-US	psi				SPRINKLER INLET PRESSURE-METRIC	bar			
	10	15	20	25		0.69	1.03	1.38	1.72
#6 Nozzle - Gold (3/32")					#6 Nozzle - Gold (2.38 mm)				
Flow (gpm)	0.78	0.95	1.10	1.23	Flow (L/hr)	177	216	250	279
MA Diameter at 1.5 ft ht (ft)	32.0	35.0	38.5	41.0	MA Diameter at 0.46 m ht (m)	9.8	10.7	11.7	12.5
HA Diameter at 1.5 ft ht (ft)	36.5	41.0	45.0	46.0	HA Diameter at 0.46 m ht (m)	11.1	12.5	13.7	14.0
#7 Nozzle - Lime (7/64")					#7 Nozzle - Lime (2.78 mm)				
Flow (gpm)	1.06	1.30	1.50	1.68	Flow (L/hr)	241	295	341	382
MA Diameter at 1.5 ft ht (ft)	33.0	36.5	40.5	41.0	MA Diameter at 0.46 m ht (m)	10.1	11.1	12.4	12.5
HA Diameter at 1.5 ft ht (ft)	40.0	46.5	47.0	50.5	HA Diameter at 0.46 m ht (m)	12.2	14.2	14.3	15.4
#8 Nozzle - Lavender (1/8")					#8 Nozzle - Lavender (3.18 mm)				
Flow (gpm)	1.40	1.71	1.98	2.21	Flow (L/hr)	318	388	450	502
MA Diameter at 1.5 ft ht (ft)	34.0	38.5	41.0	42.5	MA Diameter at 0.46 m ht (m)	10.4	11.7	12.5	13.0
HA Diameter at 1.5 ft ht (ft)	42.0	46.5	47.0	51.5	HA Diameter at 0.46 m ht (m)	12.8	14.2	14.3	15.7
#9 Nozzle - Grey (9/64")					#9 Nozzle - Grey (3.57 mm)				
Flow (gpm)	1.80	2.20	2.54	2.84	Flow (L/hr)	409	500	577	645
MA Diameter at 1.5 ft ht (ft)	34.5	40.5	42.0	43.0	MA Diameter at 0.46 m ht (m)	10.5	12.4	12.8	13.1
HA Diameter at 1.5 ft ht (ft)	44.0	47.0	50.5	52.5	HA Diameter at 0.46 m ht (m)	13.4	14.3	15.4	16.0
#10 Nozzle - Turquoise (5/32")					#10 Nozzle - Turquoise (3.97 mm)				
Flow (gpm)	2.22	2.72	3.14	3.51	Flow (L/hr)	504	618	713	797
MA Diameter at 1.5 ft ht (ft)	36.0	41.0	42.5	44.0	MA Diameter at 0.46 m ht (m)	11.0	12.5	13.0	13.4
HA Diameter at 1.5 ft ht (ft)	44.5	49.0	50.5	53.5	HA Diameter at 0.46 m ht (m)	13.6	14.9	15.4	16.3
#11 Nozzle - Yellow (11/64")					#11 Nozzle - Yellow (4.37 mm)				
Flow (gpm)	2.69	3.30	3.81	4.26	Flow (L/hr)	611	749	865	968
MA Diameter at 1.5 ft ht (ft)	36.0	41.5	43.0	44.0	MA Diameter at 0.46 m ht (m)	11.0	12.7	13.1	13.4
HA Diameter at 1.5 ft ht (ft)	44.5	50.5	51.5	54.0	HA Diameter at 0.46 m ht (m)	13.6	15.4	15.7	16.5
#12 Nozzle - Red (3/16")					#12 Nozzle - Red (4.76 mm)				
Flow (gpm)	3.23	3.96	4.57	5.11	Flow (L/hr)	734	899	1038	1161
MA Diameter at 1.5 ft ht (ft)	36.5	41.5	44.5	44.5	MA Diameter at 0.46 m ht (m)	11.1	12.7	13.6	13.6
HA Diameter at 1.5 ft ht (ft)	46.0	50.5	52.0	54.5	HA Diameter at 0.46 m ht (m)	14.0	15.4	15.9	16.6
#13 Nozzle - White (13/64")					#13 Nozzle - White (5.16 mm)				
Flow (gpm)	3.80	4.65	5.38	6.01	Flow (L/hr)	863	1056	1222	1365
MA Diameter at 1.5 ft ht (ft)	36.5	41.5	44.5	45.0	MA Diameter at 0.46 m ht (m)	11.1	12.7	13.6	13.7
HA Diameter at 1.5 ft ht (ft)	46.5	51.0	52.5	55.5	HA Diameter at 0.46 m ht (m)	14.2	15.6	16.0	16.9
#14 Nozzle - Blue (7/32")					#14 Nozzle - Blue (5.56 mm)				
Flow (gpm)	4.40	5.39	6.23	6.97	Flow (L/hr)	999	1224	1415	1583
MA Diameter at 1.5 ft ht (ft)	37.0	42.5	45.0	46.5	MA Diameter at 0.46 m ht (m)	11.3	13.0	13.7	14.2
HA Diameter at 1.5 ft ht (ft)	47.0	51.0	53.0	55.5	HA Diameter at 0.46 m ht (m)	14.3	15.6	16.2	16.9

Sprinkler performance may vary with actual field conditions. Other nozzle sizes are available. Consult factory for specific performance data. Stream heights range from 2.5 to 5.5 ft (0.8 to 1.7 m) above nozzle based on pressure and nozzle size. Minimum recommended riser height is 1.5 ft (0.46 m).

Wobbler[®] Standard & Low Angle

This model Wobbler[®] started Senninger[®] Wobbler Technology back in 1978. Still popular today, its off-center rotary-action provides extremely uniform coverage over a large diameter and delivers wind resistant droplets in a gentle rain-like pattern..



FEATURES

- Only one moving part – which translates to longer life
- Flow rates: 0.78 to 7.64 gpm (177 to 1735 L/hr)
- Operating pressures: 10 to 30 psi (0.69 to 2.07 bar)
- Low evaporative loss
- Connections: 3/4" and 1/2" male NPT



WOBBLER ON RISER WITH CONCRETE

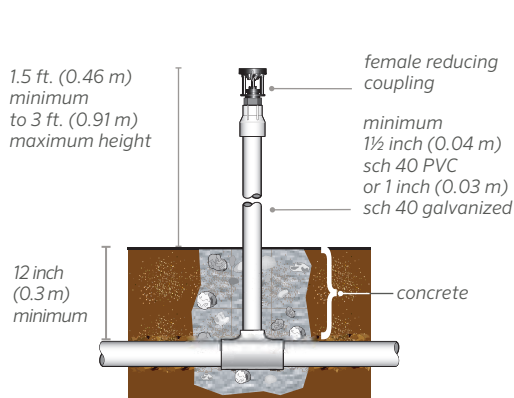

WOBBLER ON RISER SUPPORTED WITH STAKE

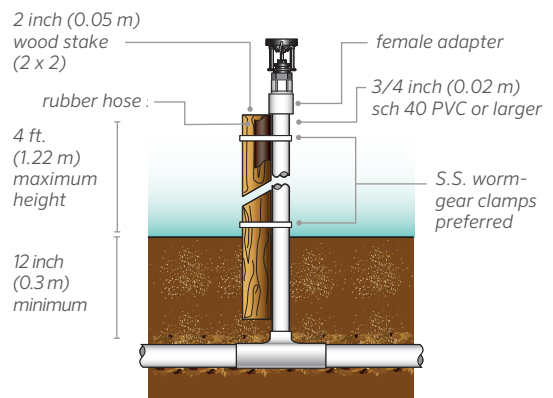

NOTE: Care must be taken to stabilize the riser. For other installation details, contact our factory.

Standard & Low Angle **Wobbler®**

SPRINKLER INLET PRESSURE-US	psi					SPRINKLER INLET PRESSURE-METRIC	bar				
	10	15	20	25	30		0.69	1.03	1.38	1.72	2.07
#6 Nozzle - Gold (3/32")						#6 Nozzle - Gold (2.38 mm)					
Flow (gpm)	0.78	0.95	1.10	1.23	1.35	Flow (L/hr)	177	216	250	279	307
SA Diameter at 1.5 ft ht (ft)	34.0	39.0	41.5	43.5	44.0	SA Diameter at 0.46 m ht (m)	10.4	11.9	12.7	13.3	13.4
LA Diameter at 1.5 ft ht (ft)	29.0	34.5	38.0	40.5	41.0	LA Diameter at 0.46 m ht (m)	8.8	10.5	11.6	12.4	12.5
#7 Nozzle - Lime (7/64")						#7 Nozzle - Lime (2.78 mm)					
Flow (gpm)	1.06	1.30	1.50	1.68	1.84	Flow (L/hr)	241	295	341	382	418
SA Diameter at 1.5 ft ht (ft)	36.5	41.5	43.5	45.0	45.5	SA Diameter at 0.46 m ht (m)	11.1	12.7	13.3	13.7	13.9
LA Diameter at 1.5 ft ht (ft)	31.5	37.0	40.0	41.5	42.0	LA Diameter at 0.46 m ht (m)	9.6	11.3	12.2	12.7	12.8
#8 Nozzle - Lavender (1/8")						#8 Nozzle - Lavender (3.18 mm)					
Flow (gpm)	1.40	1.71	1.98	2.21	2.42	Flow (L/hr)	318	388	450	502	550
SA Diameter at 1.5 ft ht (ft)	38.5	43.5	45.0	46.5	47.0	SA Diameter at 0.46 m ht (m)	11.7	13.3	13.7	14.2	14.3
LA Diameter at 1.5 ft ht (ft)	34.0	39.0	41.5	42.5	43.0	LA Diameter at 0.46 m ht (m)	10.4	11.9	12.7	13.0	13.1
#9 Nozzle - Grey (9/64")						#9 Nozzle - Grey (3.57 mm)					
Flow (gpm)	1.80	2.20	2.54	2.84	3.11	Flow (L/hr)	409	500	577	645	706
SA Diameter at 1.5 ft ht (ft)	40.5	45.5	46.5	47.5	48.0	SA Diameter at 0.46 m ht (m)	12.4	13.9	14.2	14.5	14.6
LA Diameter at 1.5 ft ht (ft)	35.5	40.5	42.5	43.5	44.0	LA Diameter at 0.46 m ht (m)	10.8	12.4	13.0	13.3	13.4
#10 Nozzle - Turquoise (5/32")						#10 Nozzle - Turquoise (3.97 mm)					
Flow (gpm)	2.22	2.72	3.14	3.51	3.85	Flow (L/hr)	504	618	713	797	874
SA Diameter at 1.5 ft ht (ft)	42.0	47.0	48.0	48.5	49.0	SA Diameter at 0.46 m ht (m)	12.8	14.3	14.6	14.8	14.9
LA Diameter at 1.5 ft ht (ft)	36.0	41.0	43.0	44.0	44.5	LA Diameter at 0.46 m ht (m)	11.0	12.5	13.1	13.4	13.6
#11 Nozzle - Yellow (11/64")						#11 Nozzle - Yellow (4.37 mm)					
Flow (gpm)	2.69	3.30	3.81	4.26	4.67	Flow (L/hr)	611	749	865	968	1061
SA Diameter at 1.5 ft ht (ft)	43.0	48.0	49.0	49.5	50.0	SA Diameter at 0.46 m ht (m)	13.1	14.6	14.9	15.1	15.3
LA Diameter at 1.5 ft ht (ft)	36.5	42.0	43.5	44.5	45.0	LA Diameter at 0.46 m ht (m)	11.1	12.8	13.3	13.6	13.7
#12 Nozzle - Red (3/16")						#12 Nozzle - Red (4.76 mm)					
Flow (gpm)	3.23	3.96	4.57	5.11	5.60	Flow (L/hr)	734	899	1038	1161	1272
SA Diameter at 1.5 ft ht (ft)	44.0	49.0	50.0	50.5	51.0	SA Diameter at 0.46 m ht (m)	13.4	14.9	15.3	15.4	15.6
LA Diameter at 1.5 ft ht (ft)	37.0	42.5	44.0	45.0	45.5	LA Diameter at 0.46 m ht (m)	11.3	13.0	13.4	13.7	13.9
#13 Nozzle - White (13/64")						#13 Nozzle - White (5.16 mm)					
Flow (gpm)	3.80	4.65	5.38	6.01	6.59	Flow (L/hr)	863	1056	1222	1365	1497
SA Diameter at 1.5 ft ht (ft)	44.5	49.5	50.5	51.0	51.5	SA Diameter at 0.46 m ht (m)	13.6	15.1	15.4	15.6	15.7
LA Diameter at 1.5 ft ht (ft)	37.5	43.0	44.5	45.5	46.0	LA Diameter at 0.46 m ht (m)	11.4	13.1	13.6	13.9	14.0
#14 Nozzle - Blue (7/32")						#14 Nozzle - Blue (5.56 mm)					
Flow (gpm)	4.40	5.39	6.23	6.97	7.64	Flow (L/hr)	999	1224	1415	1583	1735
SA Diameter at 1.5 ft ht (ft)	45.0	50.0	51.0	51.5	52.0	SA Diameter at 0.46 m ht (m)	13.7	15.3	15.6	15.7	15.9
LA Diameter at 1.5 ft ht (ft)	38.0	43.5	45.0	46.0	46.5	LA Diameter at 0.46 m ht (m)	11.6	13.3	13.7	14.0	14.2

Sprinkler performance may vary with actual field conditions. Other nozzle sizes are available. Consult factory for specific performance data. Stream heights range from 2.5 to 5.5 ft (0.8 to 1.7 m) above the nozzle based on pressure and nozzle size. Minimum recommended riser height is 1.5 ft (0.46 m).

Smooth Drive™

The Senninger® Smooth Drive™ is designed for under-tree, open-field and nursery irrigation. Its unique “walking diffuser” helps deliver an extremely uniform pattern that prevents dry areas caused by distortion from bracket legs.



FEATURES

- Low Angle model ideal for under-tree (white base)
- High Angle model ideal for open-field (black base)
- Precision-contoured deflector provides greater throw and enhanced distribution
- Advanced braking mechanism for smooth, consistent rotation speed and minimal riser stress
- No tools required for accessing nozzle
- Flow rates: 1.34 to 2.79 gpm (304 to 634 L/hr)
- Operating pressures: 25 to 40 psi (1.72 to 2.76 bar)
- Connections: 1/2" male NPT, 1/2" socket x 3/4" socket x 1" spigot, and 20 mm socket x 25 mm socket
- Solvent-weld base for theft resistance

ORDINARY DEVICES

Shadow created by fixed bracket legs

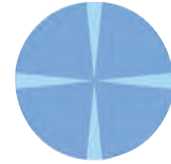

SMOOTH DRIVE

Walking diffuser eliminates leg shadow



Ordinary rotating sprinklers have stationary legs that block water and create leg shadows. The Smooth Drive's walking diffuser eliminates bracket leg shadows resulting in unobstructed, uniform distribution.

SPRINKLER INLET PRESSURE-US	psi				SPRINKLER INLET PRESSURE-METRIC	bar			
	25	30	35	40		1.72	2.07	2.41	2.76
#6 Nozzle - Gold (3/32")					#6 Nozzle - Gold (2.38 mm)				
Flow (gpm)	-	1.34	1.45	1.55	Flow (L/hr)	-	304	329	352
LA Diameter at 1.5 ft ht (ft)	-	65	67	68	LA Diameter at 0.46 m ht (m)	-	19.8	20.4	20.7
HA Diameter at 1.5 ft ht (ft)	-	68	70	72	HA Diameter at 0.46 m ht (m)	-	20.7	21.3	21.9
#7 Nozzle - Lime (7/64")					#7 Nozzle - Lime (2.78 mm)				
Flow (gpm)	1.68	1.84	1.99	2.12	Flow (L/hr)	382	418	452	482
LA Diameter at 1.5 ft ht (ft)	63	67	68	69	LA Diameter at 0.46 m ht (m)	19.2	20.4	20.7	21.0
HA Diameter at 1.5 ft ht (ft)	67	72	74	77	HA Diameter at 0.46 m ht (m)	20.4	21.9	22.6	23.8
#8 Nozzle - Lavender (1/8")					#8 Nozzle - Lavender (3.18 mm)				
Flow (gpm)	2.21	2.42	2.62	2.79	Flow (L/hr)	502	550	595	634
LA Diameter at 1.5 ft ht (ft)	65	68	69	71	LA Diameter at 0.46 m ht (m)	19.8	20.7	21.0	21.6
HA Diameter at 1.5 ft ht (ft)	70	74	77	78	HA Diameter at 0.46 m ht (m)	21.3	22.6	23.5	23.8

Sprinkler performance may vary with actual field conditions. Minimum recommended height is 1.5 ft (0.46 m).

TWO MODELS

LA model (White)

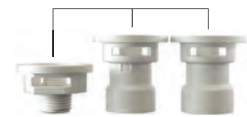

HA model (Black)



See Connections listed in Features

INVERTED ASSEMBLIES FOR FOGGERS

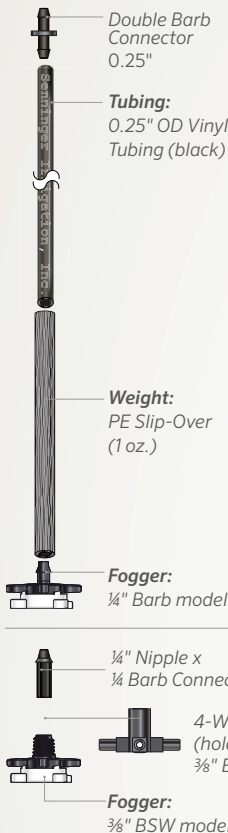

Senninger® Foggers reduce greenhouse temperatures and increase humidity levels in greenhouses. They create the ideal conditions for plant propagation by distributing extremely fine droplets with excellent pattern uniformity.



NOZZLE

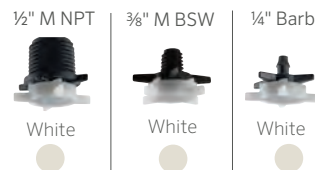

FEATURES:

- Uniform blanket of droplets for propagation and chemical applications
- Built-in check valve provides instantaneous shutoff and prevents leakage
- Simple, tool-free assembly and disassembly for cleaning
- Average flow rate per nozzle: 1.6 gph (6.05 L/hr)
- Operating pressures: 45 to 60 psi (3.10 to 4.10 bar)
- Multiple connection options: 1/2" male NPT, 3/8" male BSW, 1/4" barb, also available as 1/4" press fit
- 140 mesh filtration required

DROP ASSEMBLIES:

The Fogger can be mounted on the drop adapter with a 4-way cross adapter.

Recommended Installation:

PROPAGATION

Four Way Adapter		
Minimum Installation Height*	1.5 to 2.5 ft	(0.5 to 0.8 m)
Head Spacing	3 ft	0.9 m

*ABOVE THE PLANT- For wide benches up to 8 ft (2.4 m) in width, install two lines of Foggers equally distanced from the center of the bench to achieve a more uniform application. Do not install Fogger lines more than one foot (0.3 m) from the edge of a bench.

Recommended Installation:

COOLING AND HUMIDITY CONTROL

Four Way Adapter		
Minimum Installation Height*	3 to 6 ft	(0.9 to 1.8 m)
Head Spacing	3 to 10 ft	(0.9 to 3.0 m)
Lateral Spacing	5 to 15 ft	(1.5 to 4.6 m)

* Mount Foggers as high as possible. Install drops perpendicular to the lateral line. Avoid spraying against roof or greenhouse structure.

WHAT IS THE DIFFERENCE BETWEEN FOGGERS AND MISTERS?

	Fogger	Mister
Recommended for propagation of seeds and non-rooted cuttings	YES	NO
Recommended for propagation of rooted cuttings	NO	YES
Cooling & Humidity Control	YES	NO

Mister™ Upright

The Senninger® Mister™ is designed for propagation and other low volume misting applications. It provides consistent system start-up delivering an instantaneous, highly uniform distribution ideal for short-cycle applications.

FOUR NOZZLE SIZES

(See chart below)

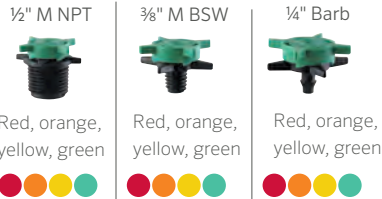

FEATURES

- Outstanding uniformity
- Flow rates: 6.8 to 23.4 gph (25.7 to 88.6 L/hr)
- Operating pressures: 30 to 50 psi (2.07 to 3.45 bar)
- Bridgeless design for an uninterrupted 360° distribution pattern
- Easy clean nozzle with tool-free disassembly
- Multiple connection options: 1/2" male NPT, 3/8" male BSW, 1/4" barb, also available as 1/4" press fit
- 140 mesh filtration required

UPRIGHT RECOMMENDED SPACING AT 12 INCH (31 CM) HEIGHT ABOVE CROP

Pressure	30 - 50 psi	2.07 - 3.45 bar
Red - MR 08	6.8 - 8.6 gph	25.7 - 32.6 L/hr
Head Spacing	2 - 4 ft	0.61 - 1.22 m
Lateral Spacing	2 - 4 ft	0.61 - 1.22 m
Single Row Spacing	2 - 3.5 ft	0.61 - 1.07 m
Orange - MR 12	10.8 - 14.0 gph	40.9 - 53.0 L/hr
Head Spacing	2 - 4 ft	0.61 - 1.22 m
Lateral Spacing	2 - 4 ft	0.61 - 1.22 m
Single Row Spacing	2 - 3 ft	0.61 - 0.91 m
Yellow - MR 16	14.1 - 18.3 gph	53.4 - 69.3 L/hr
Head Spacing	2 - 4 ft	0.61 - 1.22 m
Lateral Spacing	2 - 4 ft	0.61 - 1.22 m
Single Row Spacing	2 - 3 ft	0.61 - 0.91 m
Green - MR 20	17.8 - 23.4 gph	67.4 - 88.6 L/hr
Head Spacing	2 - 4 ft	0.61 - 1.22 m
Lateral Spacing	2 - 4 ft	0.61 - 1.22 m
Single Row Spacing	2 - 3 ft	0.61 - 0.91 m

Other spacing options may produce higher uniformities and lower scheduling co-efficiencies. Check valve option is available with different spacing recommendations. Consult factory for details. Consider friction loss through tubing when designing for optimum performance.

RISER STAKES

The Mister can be mounted on the Riser Stake for installation versatility. (See page 36)



Inverted Mister™

The Inverted Mister™ is designed for propagation and other low volume misting applications. Its built-in check valve prevents draining immediately following each irrigation session. It also provides consistent system start-up delivering an instantaneous, highly uniform distribution, ideal for short-cycle applications.



FOUR NOZZLE SIZES

(See chart below)

1/2" M NPT



Light Blue, Blue, Purple, Black



3/8" M BSW



Light Blue, Blue, Purple, Black



1/4" Barb



Light Blue, Blue, Purple, Black



INVERTED MISTER ASSEMBLY



FEATURES

- Outstanding uniformity
- Flow rates: 7.5 to 23.4 gph (28.4 to 88.6 L/hr)
- Operating pressures: 30 to 50 psi (2.07 to 3.45 bar)
- Bridgeless design for an uninterrupted 360° distribution pattern
- Easy clean nozzle with tool-free disassembly
- Multiple connection options: 1/2" male NPT, 3/8" male BSW, 1/4" barb, also available as 1/4" press fit
- 140 mesh filtration required

INVERTED RECOMMENDED SPACING AT 24 INCH (61 CM) HEIGHT ABOVE CROP

Pressure	30 - 50 psi	2.07 - 3.45 bar
Light Blue - MRI 08	7.5 - 9.7 gph	28.4 - 36.7 L/hr
Head Spacing	2 - 4 ft	0.61 - 1.22 m
Lateral Spacing	2.5 - 3.5 ft	0.76 - 1.07 m
Single Row Spacing	N/A	N/A
Blue - MRI 12	12.5 - 16.2 gph	47.3 - 61.3 L/hr
Head Spacing	2 - 3.5 ft	0.61 - 1.07 m
Lateral Spacing	2.5 - 3.5 ft	0.61 - 1.07 m
Single Row Spacing	N/A	N/A
Purple - MRI 16	15.9 - 20.5 gph	60.2 - 77.6 L/hr
Head Spacing	2 - 3 ft	0.61 - 0.91 m
Lateral Spacing	2 - 2.5 ft	0.61 - 0.76 m
Single Row Spacing	2 - 2.5 ft	0.61 - 0.76 m
Black - MRI 20	17.8 - 23.4 gph	67.4 - 88.6 L/hr
Head Spacing	2 - 2.5 ft	0.61 - 0.76 m
Lateral Spacing	2 - 3 ft	0.61 - 0.91 m
Single Row Spacing	2 - 2.5 ft	0.61 - 0.76 m

Other spacing options may produce higher uniformities and lower scheduling co-efficiencies. Consult factory for details. Consider friction loss through tubing when designing for optimum performance.

Micro-Sprinkler Upright

The upright model is ideal for nurseries, orchards, vineyards, vegetables and citrus crops.

UPRIGHT MICRO-SPRINKLER INSTALLATION

- Recommended filtration 80 to 140 mesh based on nozzle size.
- Consider friction loss through tubing when designing for optimum performance.

Consult factory for details.

UPRIGHT NOZZLE SIZES



SPRINKLER INLET PRESSURE-US	psi		SPRINKLER INLET PRESSURE-METRIC	bar	
	20	30		1.38	2.07
#2 Nozzle - Pink (1/32")			#2 Nozzle - Pink (0.79 mm)		
Flow (gph)	7.2	9.0	Flow (L/hr)	27.3	34.1
Diameter at 1.5 ft ht	18	22	Diameter at 0.46 m ht	5.5	6.7
Diameter at 3.0 ft ht	21	26	Diameter at 0.91 m ht	6.4	7.8
#3 Nozzle - Ice (3/64")			#3 Nozzle - Ice (1.19 mm)		
Flow (gph)	16.8	20.4	Flow (L/hr)	63.6	77.2
Diameter at 1.5 ft ht	24	24	Diameter at 0.46 m ht	7.3	7.3
Diameter at 3.0 ft ht	26	29	Diameter at 0.91 m ht	8.0	8.7
#4 Nozzle - Light Blue (1/16")			#4 Nozzle - Light Blue (1.59 mm)		
Flow (gph)	30.0	36.6	Flow (L/hr)	113.6	138.5
Diameter at 1.5 ft ht	27	30	Diameter at 0.46 m ht	8.1	9.1
Diameter at 3.0 ft ht	27	33	Diameter at 0.91 m ht	8.2	10.1

Consider friction loss through tubing when designing for optimum performance.

UPRIGHT MICRO-SPRINKLER - PRECIPITATION & UNIFORMITIES

at 1.5 ft (0.46 m) and 3.0 ft (0.91 m) height at 30 psi (2.07 bar)

Nozzle Number & Color	Flow Rate		10 x 10 ft (3 x 3 m)				10 x 16 ft (3 x 5 m)			
	gph	L/hr	30 psi		CU%		30 psi		CU%	
			(in/hr)	(mm/hr)	@1.5 ft (0.46 m)	@3.0 ft (0.91 m)	(in/hr)	(mm/hr)	@1.5 ft (0.46 m)	@3.0 ft (0.91 m)
#3 - Ice	20.4	77.2	0.33	8.4	88%	85%	0.67	17.0	98%	98%
#4 - Light Blue	36.6	138.5	0.59	15.0	88%	85%	1.20	30.5	99%	99%

Uniformities calculated with WinSipp™3 Software. Other spacing options available on WinSipp™3 or by consulting factory.

RISER STAKES

Riser Stakes are available in either 26" or 14" length models. (See page 36). For best results, the Riser Stake should be installed at least 1/3 its length into the ground.



RISER ADAPTER

Riser Adapter for use with a 1/2" M NPT connection Micro-Sprinkler. It can also be used for direct mounting a barbed base Micro-Sprinkler into 0.25", 0.270", or 8 mm tubing.



Inverted **Micro-Sprinkler**

The inverted model is ideal for overhead irrigation in greenhouses, shade houses and hoop houses.

INVERTED DIAMETER- PRECIPITATION & UNIFORMITIES

Single row at 6ft (1.8 m) height at 30 psi (2.07 bar)

Nozzle # & Color	Flow Rate		10 x 10 ft (3 x 3 m)			10 x 16 ft (3 x 5 m)		
	gph	L/hr	30 psi (in/hr)	2.07 bar (mm/hr)	CU	30 psi (in/hr)	2.07 bar (mm/hr)	CU
#3 - Ice	20.4	77.2	0.33	8.4	95%	0.21	5.3	93%
#4 - Light Blue	36.6	138.5	0.58	14.7	94%	0.36	9.1	93%
#5 - Beige	57.0	215.8	0.91	23.1	98%	0.57	14.5	93%
#6 - Gold	81.6	308.9	1.31	33.3	95%	0.82	20.8	94%

Uniformities calculated with WinSipp™3 Software. Other spacing options available on WinSIPP™3 or by consulting factory.

SHORT DIAMETER- PRECIPITATION & UNIFORMITIES

Single row at 3 ft (0.91 m) height at 20 and 30 psi (1.38 and 2.07 bar)

Nozzle # & Color	Flow Rate		4 ft (1.2 m) table & 3 ft (0.91 m) Spacing		
	gph	L/hr	(in/hr)	1.38 bar (mm/hr)	CU
#2 - Pink @ 20 psi (1.38 bar)	7.2	27.3	0.75	19.1	83%
#2 - Pink @ 30 psi (2.07 bar)	9.0	34.1	0.89	22.6	82%

INVERTED NOZZLE SIZES



INVERTED NOZZLE SIZES

SHORT DIAMETER

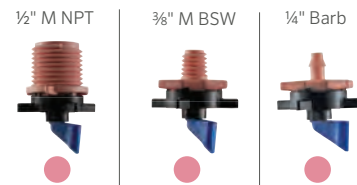

INVERTED MICRO-SPRINKLER ASSEMBLY

Double Barb Connector 0.25"

Tubing:
0.25" OD Vinyl Tubing (black)

Weight:
PE Slip-Over (1 oz.)

1/4" Nipple x 1/4" Barb Connector

Non-Drip Valve (low pressure)
0.25" F x M Press-Fit (opens at 14.5 psi (1 bar))

Micro-Sprinkler
3/8" BSW Model (#2, #3 or #4 Nozzle)

Non-Drip Valve (high pressure)
0.25" F x M Press-Fit (opens at 21.7 psi (1.5 bar))

INVERTED MICRO SPRINKLER INLET PRESSURE-US

	psi		bar	
	20	30	1.38	2.07
#2 Nozzle - Pink (1/32")			#2 Nozzle - Pink (0.79 mm)	
Flow (gph)	7.2	9.0	Flow (L/hr)	27.3 34.1
Short Diameter at 3.0 ft ht	5.2	6.1	Short Diameter at 0.9 m ht	1.6 1.9

	psi		bar	
	20	30	1.38	2.07
#3 Nozzle - Ice (3/64")			#3 Nozzle - Ice (1.19 mm)	
Flow (gph)	16.8	20.4	Flow (L/hr)	63.6 77.2
Diameter at 6.0 ft ht	29	32	Diameter at 1.83 m ht	9.0 9.6
#4 Nozzle - Lt Blue (1/16")			#4 Nozzle - Lt Blue (1.59 mm)	
Flow (gph)	30.0	36.6	Flow (L/hr)	113.6 138.5
Diameter at 6.0 ft ht	33	36	Diameter at 1.83 m ht	9.9 11.0
#5 Nozzle - Beige (5/64")			#5 Nozzle - Beige (1.98 mm)	
Flow (gph)	46.2	57.0	Flow (L/hr)	174.9 215.8
Diameter at 6.0 ft ht	38	40	Diameter at 1.83 m ht	11.7 12.1
#6 Nozzle - Gold (3/32")			#6 Nozzle - Gold (2.38 mm)	
Flow (gph)	66.6	81.6	Flow (L/hr)	252.1 308.9
Diameter at 6.0 ft ht	39	40	Diameter at 1.83 m ht	11.8 12.2

NON-DRIP VALVES

MODEL		OPENING PRESSURE		CLOSING PRESSURE	
		psi	(bar)	psi	(bar)
MISINDVL	Low pressure	14.5 +/- 1.45	1.0 +/- 0.1	5.8 +/- 1.45	0.4 +/- 0.1
MISINDVH	High pressure	21.7 +/- 2.9	1.5 +/- 0.2	10.1 +/- 1.45	0.7 +/- 0.1

Spray Stakes

Senninger® Spray Stakes are available in three patterns which correspond to various container sizes. The patterns wet the soil surface avoiding over-spray to save water, energy and fertilizer costs.

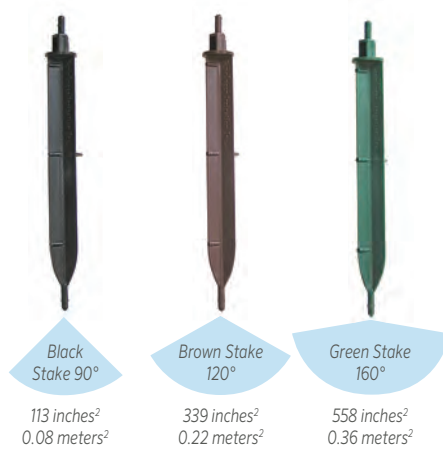

AREA OF COVERAGE

(For use with 0.125" I.D. Tubing)



FEATURES

- Flow rates: 4 to 12 gph (15.1 to 45.4 L/hr)
- Operating Pressure: 20 psi (1.38 bar)
- Directional indicator for easy positioning
- Easy to remove for cleaning and maintenance
- Shut-off feature
- Three color-coded flow rates to match application requirements

EMITTER SELECTION BASED ON CONTAINER SIZE OR AREA

Container Size	Radius of Coverage	Area of Coverage	Spray Stake	Flow @ 20 psi (1.38 bar)	Distribution Pattern
10 gallon	12 in (0.31 cm)	113 in ² (0.08 m ²)	black	4 gph (15.1 L/hr)	90 Degrees
15 gallon	18 in (0.46 cm)	339 in ² (0.22 m ²)	brown	8 gph (30.3 L/hr)	120 Degrees
30 gallon	20 in (0.51 cm)	555 in ² (0.36 m ²)	green	12 gph (45.4 L/hr)	160 Degrees

Consider friction loss through the tubing when designing for optimum performance.



The Senninger® T-Spray™ delivers a fine 360° spray ideal for delicate stock. Mounting can be either upright or inverted. The T-Spray is also available in a high-angle upright model providing a larger coverage area

FEATURES

- No moving parts for longer life
- Removable T-stem for easy cleaning
- Flow rates: 0.98 to 2.85 gpm (223 to 647 L/hr)
- Operating pressures: 15 to 40 psi (1.03 to 2.76 bar)
- Connection: 1/2" male NPT

Standard Angle (Inverted & Upright)



THREE T-STEMS

Gold, Lime & Lavendar
(See chart below)



High Angle (Upright)



Dark Purple
(See chart below)



SPRINKLER INLET PRESSURE-US	psi						SPRINKLER INLET PRESSURE-METRIC	bar					
	15	20	25	30	35	40		1.03	1.38	1.72	2.07	2.41	2.76
#6 T-Stem - Gold							#6 T-Stem - Gold						
Flow (gpm)	0.98	1.14	1.27	1.40	1.52	1.63	Flow (L/hr)	223	259	288	318	345	370
Diameter at 1.5 ft ht (ft)	15.5	17.0	18.0	19.0	20.0	21.0	Diameter at 0.46 m ht (m)	4.7	5.2	5.5	5.8	6.1	6.4
Diameter at 3.0 ft ht (ft)	17.5	18.5	19.5	20.5	21.5	22.0	Diameter at 0.91 m ht (m)	5.3	5.6	5.9	6.2	6.6	6.7
#7 T-Stem - Lime							#7 T-Stem - Lime						
Flow (gpm)	1.34	1.56	1.73	1.90	2.05	2.20	Flow (L/hr)	304	354	393	432	466	500
Diameter at 1.5 ft ht (ft)	17.0	18.5	19.5	20.5	21.0	21.5	Diameter at 0.46 m ht (m)	5.2	5.6	5.9	6.2	6.4	6.6
Diameter at 3.0 ft ht (ft)	18.5	19.5	20.5	21.5	22.5	23.0	Diameter at 0.91 m ht (m)	5.6	5.9	6.3	6.6	6.9	7.0
#8 T-Stem - Lavender							#8 T-Stem - Lavender						
Flow (gpm)	1.73	2.01	2.23	2.45	2.65	2.85	Flow (L/hr)	393	457	506	556	602	647
Diameter at 1.5 ft ht (ft)	18.0	19.5	20.5	21.0	21.5	22.0	Diameter at 0.46 m ht (m)	5.5	5.9	6.2	6.4	6.6	6.7
Diameter at 3.0 ft ht (ft)	19.0	20.0	21.0	22.0	23.0	23.5	Diameter at 0.91 m ht (m)	5.8	6.1	6.4	6.7	7.0	7.2

HIGH ANGLE - UPRIGHT ONLY

#8 T-Stem HA - Dark Purple							#8 T-Stem HA - Dark Purple						
Flow (gpm)	1.73	2.01	2.23	2.45	2.65	2.85	Flow (L/hr)	393	457	506	556	602	647
Diameter at 1.5 ft ht (ft)	25.5	27.5	29.0	30.0	31.0	32.0	Diameter at 0.46 m ht (m)	7.8	8.4	8.8	9.1	9.4	9.8

Sprinkler performance may vary with actual field conditions. Minimum recommended riser height is 1.5 ft (0.46 m).

Triad™

The Senninger® Triad™ is a unique, three-stream sprinkler for orchard irrigation that's ideal for irrigating small root zones associated with young trees. It requires less filtration than traditional micro-irrigation.



FEATURES

- Ideal for oil palms, pecans, coconuts, mangos, citrus, walnut and other fruit trees
- Fewer laterals allow greater access to trees for harvesting and orchard maintenance
- Three adjustable nozzles for precise direction and trajectory control
- Flow rates: 0.94 to 1.82 gpm (213 to 413 L/hr)
- Operating pressures: 10 to 35 psi (0.69 to 2.41 bar)
- 3/4" female slip and 25 mm female base
- Solvent welds directly to PVC riser – no need for a connecting fitting
- Reduces the number of laterals required by 50% compared to micro sprinklers

INSTALLATION VERSATILITY:

The Senninger Triad with the 3/4" base can also be installed on Smooth Drive bases for a quick and economic conversion to Smooth Drive sprinklers once plants mature. (See page 10 for Smooth Drive base options.)

Triad Complete, base and nozzles (TR13SS040R040R040R)



Smooth Drive Adaptor (FTASDX3MS)



Smooth Drive Base (SD23SBHA)



TRIANGULAR PLANTING RECTANGULAR PLANTING

The Triad uses one line of polyethylene tube every other row and one emitter for every three trees.

Tree diking is recommended for best water retention.

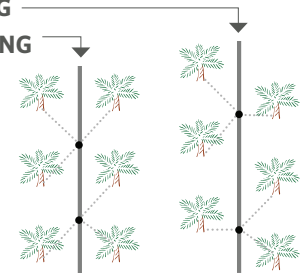

SPRINKLER INLET PRESSURE-US

	psi					
	10	15	20	25	30	35
0 Degree Trajectory						
Flow* (gpm)	0.94	1.16	1.36	1.52	1.68	1.82
Radius Min. throw 1.5 ft (ft)	9.5	12.0	13.0	13.0	13.0	13.0
Radius Max. throw 1.5 ft (ft)	10.0	13.5	15.0	16.5	17.0	17.5
30 Degree Trajectory						
Flow* (gpm)	0.94	1.16	1.36	1.52	1.68	1.82
Radius Min. throw 1.5 ft (ft)	17.5	23.5	25.0	25.5	26.0	26.5
Radius Max. throw 1.5 ft (ft)	21.5	29.0	31.5	32.5	33.5	34.5

SPRINKLER INLET PRESSURE-METRIC

	bar					
	0.69	1.03	1.38	1.72	2.07	2.41
0 Degree Trajectory						
Flow* (L/hr)	213	263	309	345	381	413
Radius Min. throw 0.46 m (m)	2.9	3.7	4.0	4.0	4.0	4.0
Radius Max. throw 0.46 m (m)	3.0	4.1	4.6	5.0	5.2	5.3
30 Degree Trajectory						
Flow* (L/hr)	213	263	309	345	381	413
Radius Min. throw 0.46 m (m)	5.3	7.2	7.6	7.8	7.9	8.1
Radius Max. throw 0.46 m (m)	6.6	8.8	9.6	9.9	10.2	10.5

* Flow rate is for all three nozzles combined.

Super Spray®

The Super Spray® delivers a 360° spray pattern. With no moving parts and durable construction, the Super Spray is reliable in harsh conditions. Its interchangeable deflector pads allow customization of spray angle and droplet size. It is ideal for surface water due to the distance between the nozzle and deflector pad and the deflector pad and the bracket.

FEATURES

- Easy clean nozzle design: Pinch and pull to remove the nozzle, then place and click to reinstall
- Connections: 3/4" male NPT
- Flow rates: 0.55 to 6.48 gpm (125 to 1472 L/hr)
- Operating pressures: 10 to 40 psi (0.69 to 2.76 bar)
- Deflector pads available in flat (black), concave (blue), convex (green) and smooth, medium-grooved or deep-grooved surfaces

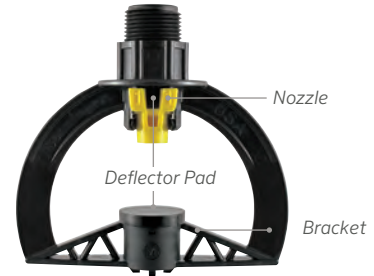

SPRINKLER INLET PRESSURE-US	psi							SPRINKLER INLET PRESSURE-METRIC	bar						
	10	15	20	25	30	35	40		0.69	1.04	1.38	1.72	2.07	2.42	2.76
#5 Nozzle - Beige (5/64")								#5 Nozzle - Beige (1.98 mm)							
Flow (gpm)	0.55	0.68	0.78	0.87	0.96	1.04	1.11	Flow (L/hr)	125	154	177	198	218	236	252
Diameter at 3.0 ft ht (ft)	15.0	17.0	18.0	18.5	19.0	19.5	20.0	Diameter at 0.91 m ht (m)	4.6	5.2	5.5	5.6	5.8	5.9	6.1
Diameter at 6.0 ft ht (ft)	15.5	17.5	19.5	21.5	22.5	23.5	24.5	Diameter at 1.83 m ht (m)	4.7	5.3	5.9	6.6	6.9	7.2	7.5
#6 Nozzle - Gold (3/32")								#6 Nozzle - Gold (2.38 mm)							
Flow (gpm)	0.80	0.98	1.13	1.26	1.38	1.50	1.60	Flow (L/hr)	182	223	257	286	313	341	363
Diameter at 3.0 ft ht (ft)	16.0	17.5	18.5	19.5	20.0	20.5	21.0	Diameter at 0.91 m ht (m)	4.9	5.3	5.6	5.9	6.1	6.2	6.4
Diameter at 6.0 ft ht (ft)	17.5	19.5	21.5	23.5	24.5	25.5	26.5	Diameter at 1.83 m ht (m)	5.3	5.9	6.6	7.2	7.5	7.8	8.1
#7 Nozzle - Lime (7/64")								#7 Nozzle - Lime (2.78 mm)							
Flow (gpm)	1.09	1.34	1.54	1.73	1.89	2.04	2.18	Flow (L/hr)	248	304	350	393	429	463	495
Diameter at 3.0 ft ht (ft)	16.5	18.0	19.5	20.5	21.5	22.0	22.5	Diameter at 0.91 m ht (m)	5.0	5.5	5.9	6.2	6.6	6.7	6.9
Diameter at 6.0 ft ht (ft)	19.5	21.5	23.5	25.5	26.5	27.5	28.5	Diameter at 1.83 m ht (m)	5.9	6.6	7.2	7.8	8.1	8.4	8.7
#8 Nozzle - Lavender (1/8")								#8 Nozzle - Lavender (3.18 mm)							
Flow (gpm)	1.43	1.75	2.02	2.26	2.48	2.68	2.86	Flow (L/hr)	325	397	459	513	563	609	650
Diameter at 3.0 ft ht (ft)	17.0	18.5	20.5	22.5	23.5	24.0	24.5	Diameter at 0.91 m ht (m)	5.2	5.6	6.2	6.9	7.2	7.3	7.5
Diameter at 6.0 ft ht (ft)	21.0	23.0	25.0	27.0	28.0	29.0	30.0	Diameter at 1.83 m ht (m)	6.4	7.0	7.6	8.2	8.5	8.8	9.1
#9 Nozzle - Grey (9/64")								#9 Nozzle - Grey (3.57 mm)							
Flow (gpm)	1.81	2.22	2.56	2.87	3.14	3.39	3.63	Flow (L/hr)	411	504	581	652	713	770	824
Diameter at 3.0 ft ht (ft)	17.5	19.5	21.5	23.5	25.0	26.0	26.5	Diameter at 0.91 m ht (m)	5.3	5.9	6.6	7.2	7.6	7.9	8.1
Diameter at 6.0 ft ht (ft)	22.0	25.0	27.0	29.0	30.0	31.0	32.0	Diameter at 1.83 m ht (m)	6.7	7.6	8.2	8.8	9.1	9.4	9.8
#10 Nozzle - Turquoise (5/32")								#10 Nozzle - Turquoise (3.97 mm)							
Flow (gpm)	2.24	2.75	3.17	3.55	3.88	4.20	4.49	Flow (L/hr)	509	625	720	806	881	954	1020
Diameter at 3.0 ft ht (ft)	18.5	21.0	23.0	25.0	26.5	27.5	28.0	Diameter at 0.91 m ht (m)	5.6	6.4	7.0	7.6	8.1	8.4	8.5
Diameter at 6.0 ft ht (ft)	23.0	26.0	28.0	30.0	31.0	32.0	33.0	Diameter at 1.83 m ht (m)	7.0	7.9	8.5	9.1	9.4	9.8	10.1
#11 Nozzle - Yellow (11/64")								#11 Nozzle - Yellow (4.37 mm)							
Flow (gpm)	2.72	3.33	3.84	4.30	4.71	5.08	5.43	Flow (L/hr)	618	756	872	977	1070	1154	1233
Diameter at 3.0 ft ht (ft)	20.5	23.0	25.0	27.0	28.5	29.5	30.0	Diameter at 0.91 m ht (m)	6.2	7.0	7.6	8.2	8.7	9.0	9.1
Diameter at 6.0 ft ht (ft)	24.0	27.0	29.0	31.0	32.0	33.0	34.0	Diameter at 1.83 m ht (m)	7.3	8.2	8.8	9.4	9.8	10.1	10.4
#12 Nozzle - Red (3/16")								#12 Nozzle - Red (4.76 mm)							
Flow (gpm)	3.24	3.97	4.58	5.12	5.61	6.06	6.48	Flow (L/hr)	736	902	1040	1163	1274	1376	1472
Diameter at 3.0 ft ht (ft)	22.5	25.0	27.0	29.0	30.5	31.5	32.0	Diameter at 0.91 m ht (m)	6.9	7.6	8.2	8.8	9.3	9.6	9.8
Diameter at 6.0 ft ht (ft)	25.0	28.0	30.0	32.0	33.0	34.0	35.0	Diameter at 1.83 m ht (m)	7.6	8.5	9.1	9.8	10.1	10.4	10.7

Sprinkler performance may vary with actual field conditions. Performance data shown is based on the Super Spray being used with the flat, smooth deflector pad. Other nozzle sizes and deflector pads are available. Consult factory for specific performance data. Stream height is approximately the same as the nozzle height when using the flat smooth deflector pad under no wind conditions.

20 Series

The 20 Series are the most economical Senninger® full-circle impacts. The series includes several models available for risers or under-tree installations.



FEATURES

- Three models with different trajectories available:
2009 - 9° fights wind drift and evaporation
2014 - 14° ideal for under-tree irrigation
2023 - 23° maximum throw on risers
- Wide range of nozzle and vane combinations for excellent distribution at all pressures
- Built-in hex wrench for easy, in-the-field maintenance
- Connections: 1/2" male NPT (female also available)
- Flow rates: 1.34 to 3.98 gpm (304 to 904 L/hr)
- Operating pressures: 30 to 50 psi (2.07 to 3.45 bar)

CONVENIENT HAND TIGHT NOZZLES™

No tools required with the easy change/easy clean nozzle and vane combination. Half size and square orifice nozzles also available.



2009HS SPRINKLER INLET PRESSURE- US	psi					SPRINKLER INLET PRESSURE-METRIC	bar				
	30	35	40	45	50		2.07	2.41	2.76	3.10	3.45
#6 Nozzle - Gold (3/32")						#6 Nozzle - Gold (2.38 mm)					
Flow (gpm)	1.34	1.45	1.55	1.64	---	Flow (L/hr)	304	329	352	372	---
Diameter at 1.5 ft ht (ft)	58	60	62	64	---	Diameter at 0.46 m ht (m)	17.7	18.3	18.9	19.5	---
#7 Nozzle - Lime (7/64")						#7 Nozzle - Lime (2.78 mm)					
Flow (gpm)	1.84	1.99	2.12	2.25	2.37	Flow (L/hr)	418	452	482	511	538
Diameter at 1.5 ft ht (ft)	60	62	64	66	67	Diameter at 0.46 m ht (m)	18.3	18.9	19.5	20.1	20.4
#8 Nozzle - Lavender (1/8")						#8 Nozzle - Lavender (3.18 mm)					
Flow (gpm)	2.42	2.62	2.79	2.97	3.12	Flow (L/hr)	550	595	634	675	709
Diameter at 1.5 ft ht (ft)	62	64	66	68	69	Diameter at 0.46 m ht (m)	18.9	19.5	20.1	20.7	21.0
#9 Nozzle - Grey (9/64")						#9 Nozzle - Grey (3.57 mm)					
Flow (gpm)	3.08	3.33	3.56	3.78	3.98	Flow (L/hr)	700	756	809	859	904
Diameter at 1.5 ft ht (ft)	64	66	68	70	71	Diameter at 0.46 m ht (m)	19.5	20.1	20.7	21.3	21.6

Sprinkler performance may vary with actual field conditions. Stream heights range from 1.5 to 3.0 ft (0.46 to 0.91 m) above the nozzle based on pressure and nozzle size. Minimum recommended riser height is 1.5 ft (0.46 m).

20 Series

MOUNTING OPTIONS

20 Series sprinklers can be ordered pre-assembled with VR and QC bases. The 20 Series impacts are available with a 1/2" NPT x 3/4" Vandal-Resistant (VR) slip base and wrench for easy removal from a sprinkler fitting, or a 1/2" NPT Quick-Connect (QC) upper fitting with a 1/2" and 3/4" slip or 20 mm and 25 mm slip coupling to retrofit your 1/2" NPT male sprinklers.

20 SERIES: 9°, 14° OR 23°

Model of sprinkler comes with solvent weld VR connection

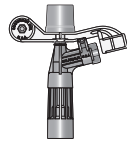

Fitting glues to riser making it vandal resistant.

1/2" VANDAL-RESISTANT (VR)

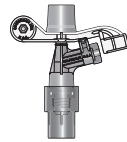

Fitting glues to riser



Vandal-Resistant Wrench required for removing sprinkler from fitting.

20 SERIES: 9°, 14° OR 23°

Model of sprinkler comes with quick-connection.

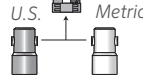
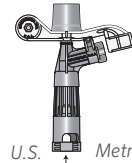

The quick-connect requires one of the lower QC fittings above.

1/2" F NPT

Fitting to convert 1/2" M NPT connection sprinklers

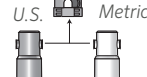

The quick-connect requires an upper fitting and one of the lower QC fittings above.

2014HS SPRINKLER INLET PRESSURE-US

	psi					SPRINKLER INLET PRESSURE-METRIC	bar				
	30	35	40	45	50		2.07	2.41	2.76	3.10	3.45
#6 Nozzle - Gold (3/32")						#6 Nozzle - Gold (2.38 mm)					
Flow (gpm)	1.34	1.45	1.55	1.64	---	Flow (L/hr)	304	329	352	372	---
Diameter at 1.5 ft ht (ft)	66	68	70	72	---	Diameter at 0.46 m ht (m)	20.1	20.7	21.4	22.0	---
#7 Nozzle - Lime (7/64")						#7 Nozzle - Lime (2.78 mm)					
Flow (gpm)	1.84	1.99	2.12	2.25	2.37	Flow (L/hr)	418	452	482	511	538
Diameter at 1.5 ft ht (ft)	68	70	72	74	75	Diameter at 0.46 m ht (m)	20.7	21.4	22.0	22.6	22.9
#8 Nozzle - Lavender (1/8")						#8 Nozzle - Lavender (3.18 mm)					
Flow (gpm)	2.42	2.62	2.79	2.97	3.12	Flow (L/hr)	550	595	634	675	709
Diameter at 1.5 ft ht (ft)	70	72	74	76	77	Diameter at 0.46 m ht (m)	21.4	22.0	22.6	23.2	23.5
#9 Nozzle - Grey (9/64")						#9 Nozzle - Grey (3.57 mm)					
Flow (gpm)	3.08	3.33	3.56	3.78	3.98	Flow (L/hr)	700	756	809	859	904
Diameter at 1.5 ft ht (ft)	71	73	75	77	78	Diameter at 0.46 m ht (m)	21.7	22.3	22.9	23.5	23.8

Sprinkler performance may vary with actual field conditions. Stream heights range from 3.0 to 5.0 ft (0.91 to 1.5 m) above nozzle based on pressure and nozzle size. Minimum recommended riser height is 1.5 ft (0.46 m).

2023HS SPRINKLER INLET PRESSURE-US

	psi					SPRINKLER INLET PRESSURE-METRIC	bar				
	30	35	40	45	50		2.07	2.41	2.76	3.10	3.45
#6 Nozzle - Gold (3/32")						#6 Nozzle - Gold (2.38 mm)					
Flow (gpm)	1.34	1.45	1.55	1.64	---	Flow (L/hr)	304	329	352	372	---
Diameter at 1.5 ft ht (ft)	74	75	76	77	---	Diameter at 0.46 m ht (m)	22.6	22.9	23.2	23.5	---
#7 Nozzle - Lime (7/64")						#7 Nozzle - Lime (2.78 mm)					
Flow (gpm)	1.84	1.99	2.12	2.25	2.37	Flow (L/hr)	418	452	482	511	538
Diameter at 1.5 ft ht (ft)	76	77	78	79	80	Diameter at 0.46 m ht (m)	23.2	23.5	23.8	24.1	24.4
#8 Nozzle - Lavender (1/8")						#8 Nozzle - Lavender (3.18 mm)					
Flow (gpm)	2.42	2.62	2.79	2.97	3.12	Flow (L/hr)	550	595	634	675	709
Diameter at 1.5 ft ht (ft)	78	79	80	81	82	Diameter at 0.46 m ht (m)	23.8	24.1	24.4	24.7	25.0
#9 Nozzle - Grey (9/64")						#9 Nozzle - Grey (3.57 mm)					
Flow (gpm)	3.08	3.33	3.56	3.78	3.98	Flow (L/hr)	700	756	809	859	904
Diameter at 1.5 ft ht (ft)	79	80	81	82	83	Diameter at 0.46 m ht (m)	24.1	24.4	24.7	25.0	25.3

Sprinkler performance may vary with actual field conditions. Stream heights range from 6.5 to 9.5 ft (2.0 to 3.0 m) above nozzle based on pressure and nozzle size. Minimum recommended riser height is 1.5 ft (0.46 m).

Compact Impact

The Compact Impact's splasharm diffuser splits the stream, distributing water more uniformly over the wetted area. It emulates dual nozzle performance without the clogging potential often found with smaller secondary nozzles.



The diffuser distributes some of the flow closer to the sprinkler for better uniformity of application.



3/4" MALE OR FEMALE BASE

FEATURES

- 23° trajectory for maximum throw
- Connections: 3/4" male NPT or 3/4" female NPT
- Flow rates: 3.08 to 7.13 gpm (700 to 1619 L/hr)
- Operating pressures: 30 to 50 psi (2.07 to 3.45 bar)

CONVENIENT HAND TIGHT NOZZLES™

No tools required with the easy change/easy clean nozzle and vane combination. Half size and square orifice nozzles also available.



Splasharm top view

VIEWS OF DISTRIBUTION

Stream driven applicators typically provide good throw distance, but their distinct streams place most of the flow in a relatively small area when compared to the Compact Impact. This model wets a larger area with lower instantaneous application intensity, preserving soil structure and infiltration capability.

COMPACT IMPACT SPRINKLER INLET PRESSURE-US	psi					SPRINKLER INLET PRESSURE-METRIC	bar				
	30	35	40	45	50		2.07	2.41	2.76	3.10	3.45
#9 Nozzle - Grey (9/64")						#9 Nozzle - Grey (3.57 mm)					
Flow (gpm)	3.08	3.33	3.56	3.78	3.98	Flow (L/hr)	700	756	809	859	904
Diameter at 1.5 ft ht (ft)	78	78	82	86	86	Diameter at 0.46 m ht (m)	24	24	25	26	26
Diameter at 3.0 ft ht (ft)	84	86	87	88	90	Diameter at 0.91 m ht (m)	26	26	27	27	27
#10 Nozzle - Turquoise (5/32")						#10 Nozzle - Turquoise (3.97 mm)					
Flow (gpm)	3.82	4.13	4.41	4.68	4.93	Flow (L/hr)	868	938	1002	1063	1120
Diameter at 1.5 ft ht (ft)	80	82	82	86	88	Diameter at 0.46 m ht (m)	24	25	25	26	27
Diameter at 3.0 ft ht (ft)	86	87	89	91	92	Diameter at 0.91 m ht (m)	26	27	27	28	28
#11 Nozzle - Yellow (11/64")						#11 Nozzle - Yellow (4.37 mm)					
Flow (gpm)	4.63	5.00	5.34	5.67	5.98	Flow (L/hr)	1052	1136	1213	1288	1358
Diameter at 1.5 ft ht (ft)	82	82	86	88	90	Diameter at 0.46 m ht (m)	25	25	26	27	27
Diameter at 3.0 ft ht (ft)	88	89	92	94	95	Diameter at 0.91 m ht (m)	27	27	28	29	29
#12 Nozzle - Red (3/16")						#12 Nozzle - Red (4.76 mm)					
Flow (gpm)	5.52	5.97	6.37	6.76	7.13	Flow (L/hr)	1254	1356	1447	1535	1619
Diameter at 1.5 ft ht (ft)	83	87	90	92	96	Diameter at 0.46 m ht (m)	25	27	27	28	29
Diameter at 3.0 ft ht (ft)	89	91	94	97	98	Diameter at 0.91 m ht (m)	27	28	29	30	30

Sprinkler performance may vary with field conditions. Stream heights range from 7.7 to 10.1 ft (2.3 to 3.1 m) above nozzle based on pressure and nozzle size. Minimum recommended riser height is 1.5 ft (0.46 m).

STANDARD IMPACT



COMPACT IMPACT



The Compact Impact distributes the same amount of water more uniformly than a single stream driven applicator.

WedgeDrive™



The 20 Series WedgeDrive™ sprinkler alternately deflects flows in front and behind the splasharm as the wedge diffuser reacts to an incoming water stream. Its square orifice nozzle and rapid 360° rotation speed at low pressures delivers uniform distribution near and away from the sprinkler.

FEATURES

- 14° or 23° model trajectories
- Flow rates: 0.84 to 3.98 gpm (191 to 904 L/hr)
- Operating pressures: 25 to 50 psi (1.72 to 3.45 bar)
- Connections: 1/2" male NPT



Splasharm top view



CONVENIENT HAND TIGHT NOZZLES™

No tools required with the easy change/easy clean nozzle and vane combination. Half size and square orifice nozzles also available.

WEDGE DRIVE SPRINKLER INLET PRESSURE-US	psi						SPRINKLER INLET PRESSURE-METRIC	bar					
	25	30	35	40	45	50		1.72	2.07	2.41	2.76	3.10	3.45
#5 Nozzle - Beige (5/64")							#5 Nozzle - Beige (1.98 mm)						
Flow (gpm)	0.84	0.92	0.99	1.06	1.13	1.19	Flow (L/hr)	191	209	225	241	257	270
2014 Diameter at 1.5 ft ht (ft)	60	61	65	67	68	69	2014 Diameter at 0.46 m ht (m)	18	19	20	20	21	21
2023 Diameter at 1.5 ft ht (ft)	70	70	70	72	76	75	2023 Diameter at 0.46 m ht (m)	21	21	21	22	23	23
#6 Nozzle - Gold (3/32")							#6 Nozzle - Gold (2.38 mm)						
Flow (gpm)	1.22	1.34	1.45	1.55	1.64	1.73	Flow (L/hr)	277	304	329	352	372	393
2014 Diameter at 1.5 ft ht (ft)	61	64	68	70	72	73	2014 Diameter at 0.46 m ht (m)	19	20	21	21	22	22
2023 Diameter at 1.5 ft ht (ft)	68	70	72	73	78	76	2023 Diameter at 0.46 m ht (m)	21	21	22	22	24	23
#7 Nozzle - Lime (7/64")							#7 Nozzle - Lime (2.78 mm)						
Flow (gpm)	1.68	1.84	1.99	2.12	2.25	2.37	Flow (L/hr)	382	418	452	482	511	538
2014 Diameter at 1.5 ft ht (ft)	64	66	70	74	76	77	2014 Diameter at 0.46 m ht (m)	20	20	21	23	23	23
2023 Diameter at 1.5 ft ht (ft)	72	73	74	76	77	78	2023 Diameter at 0.46 m ht (m)	22	22	23	23	23	24
#8 Nozzle - Lavender (1/8")							#8 Nozzle - Lavender (3.18 mm)						
Flow (gpm)	2.21	2.42	2.62	2.79	2.97	3.12	Flow (L/hr)	502	550	595	634	675	709
2014 Diameter at 1.5 ft ht (ft)	67	70	73	77	79	80	2014 Diameter at 0.46 m ht (m)	20	21	22	23	24	24
2023 Diameter at 1.5 ft ht (ft)	74	76	77	78	79	80	2023 Diameter at 0.46 m ht (m)	23	23	23	24	24	24
#9 Nozzle - Grey (9/64")							#9 Nozzle - Grey (3.57 mm)						
Flow (gpm)	2.81	3.08	3.33	3.56	3.78	3.98	Flow (L/hr)	638	700	756	809	859	904
2014 Diameter at 1.5 ft ht (ft)	68	72	76	78	81	81	2014 Diameter at 0.46 m ht (m)	21	22	23	24	25	25
2023 Diameter at 1.5 ft ht (ft)	78	78	80	81	82	83	2023 Diameter at 0.46 m ht (m)	24	24	24	25	25	25

Sprinkler performance may vary with field conditions. Stream heights for 2014 range from 6.5 to 9.5 ft (2.0 to 3.0 m) above the nozzle based on pressure and nozzle size. Minimum recommended riser height is 1.5 ft (0.46 m).

30 Series



The Senninger® 30 Series impact sprinklers deliver lower flows than the 40 or 50 Series models.

FEATURES

- Wide range of nozzle and vane combinations for excellent distribution at all pressures
- Built-in hex wrench for easy in-the-field maintenance
- 23° model available with double nozzle
- Two trajectories available: 12° - ideal for under-tree irrigation
23° - maximum throw on over head systems
- Connection: 3/4" male NPT (female also available)
- Flow rates: 1.84 to 6.42 gpm (418 to 1458 L/hr)
- Operating pressures: 30 to 50 psi (2.07 to 3.45 bar)



CONVENIENT HAND TIGHT NOZZLES™

No tools required with the easy change/easy clean nozzle and vane combination. Half size and square orifice nozzles also available.

3012-1 SPRINKLER INLET PRESSURE-US

	psi				
	30	35	40	45	50
#7 Nozzle - Lime (7/64")					
Flow (gpm)	1.84	1.99	2.12	2.25	2.37
Diameter at 1.5 ft ht (ft)	71	74	77	80	82
#8 Nozzle - Lavender (1/8")					
Flow (gpm)	2.42	2.62	2.79	2.97	3.12
Diameter at 1.5 ft ht (ft)	73	76	79	82	84
#9 Nozzle - Grey (9/64")					
Flow (gpm)	3.08	3.33	3.56	3.78	3.98
Diameter at 1.5 ft ht (ft)	75	78	81	84	86
#10 Nozzle - Turquoise (5/32")					
Flow (gpm)	3.82	4.13	4.41	4.68	4.93
Diameter at 1.5 ft ht (ft)	76	79	82	85	87

SPRINKLER INLET PRESSURE-METRIC

	bar				
	2.07	2.41	2.76	3.10	3.45
#7 Nozzle - Lime (2.78 mm)					
Flow (L/hr)	418	452	482	511	538
Diameter at 0.46 m ht (m)	21.6	22.6	23.5	24.4	25.0
#8 Nozzle - Lavender (3.18 mm)					
Flow (L/hr)	550	595	634	675	709
Diameter at 0.46 m ht (m)	22.3	23.2	24.1	25.0	25.6
#9 Nozzle - Grey (3.57 mm)					
Flow (L/hr)	700	756	809	859	904
Diameter at 0.46 m ht (m)	22.9	23.8	24.7	25.6	26.2
#10 Nozzle - Turquoise (3.97 mm)					
Flow (L/hr)	868	938	1002	1063	1120
Diameter at 0.46 m ht (m)	23.2	24.1	25.0	25.9	26.5

Sprinkler performance may vary with actual field conditions. Stream heights range from 2.5 to 4.5 ft (0.8 to 1.4 m) above nozzle based on pressure and nozzle size. Minimum recommended riser height is 1.5 ft (0.46 m).

30 Series

3023-1 SPRINKLER INLET PRESSURE-US	psi					SPRINKLER INLET PRESSURE-METRIC	bar				
	30	35	40	45	50		2.07	2.41	2.76	3.10	3.45
#7 Nozzle - Lime (7/64")						#7 Nozzle - Lime (2.78 mm)					
Flow (gpm)	1.84	1.99	2.12	2.25	2.37	Flow (L/hr)	418	452	482	511	538
Diameter at 1.5 ft ht (ft)	80	82	84	86	87	Diameter at 0.46 m ht (m)	24.4	25.0	25.6	26.2	26.5
Diameter at 6.0 ft ht (ft)	83	84	85	86	88	Diameter at 1.83 m ht (m)	25.3	25.6	25.9	26.2	26.8
#8 Nozzle - Lavender (1/8")						#8 Nozzle - Lavender (3.18 mm)					
Flow (gpm)	2.42	2.62	2.79	2.97	3.12	Flow (L/hr)	550	595	634	675	709
Diameter at 1.5 ft ht (ft)	83	85	86	87	88	Diameter at 0.46 m ht (m)	25.3	25.9	26.2	26.5	26.8
Diameter at 6.0 ft ht (ft)	86	87	88	89	90	Diameter at 1.83 m ht (m)	26.2	26.5	26.8	27.1	27.4
#9 Nozzle - Grey (9/64")						#9 Nozzle - Grey (3.57 mm)					
Flow (gpm)	3.08	3.33	3.56	3.78	3.98	Flow (L/hr)	700	756	809	859	904
Diameter at 1.5 ft ht (ft)	85	87	88	90	91	Diameter at 0.46 m ht (m)	25.9	26.5	26.8	27.4	27.7
Diameter at 6.0 ft ht (ft)	87	89	90	91	92	Diameter at 1.83 m ht (m)	26.5	27.1	27.4	27.7	28.0
#10 Nozzle - Turquoise (5/32")						#10 Nozzle - Turquoise (3.97 mm)					
Flow (gpm)	3.82	4.13	4.41	4.68	4.93	Flow (L/hr)	868	938	1002	1063	1120
Diameter at 1.5 ft ht (ft)	87	89	90	91	92	Diameter at 0.46 m ht (m)	26.5	27.1	27.4	27.7	28.0
Diameter at 6.0 ft ht (ft)	88	90	92	93	94	Diameter at 1.83 m ht (m)	26.8	27.4	28.0	28.3	28.7

3023-2 SPRINKLER INLET PRESSURE-US	psi					SPRINKLER INLET PRESSURE-METRIC	bar				
	30	35	40	45	50		2.07	2.41	2.76	3.10	3.45
7x4 #7 Range Nozzle x #4 Spreader Nozzle						7x4 #7 Range Nozzle x #4 Spreader Nozzle					
Flow (gpm)	3.01	3.25	3.48	3.69	3.89	Flow (L/hr)	684	738	790	838	884
Diameter at 1.5 ft ht (ft)	80	82	84	86	87	Diameter at 0.46 m ht (m)	24.4	25.0	25.6	26.2	26.5
Diameter at 6.0 ft ht (ft)	83	84	85	86	88	Diameter at 1.83 m ht (m)	25.3	25.6	25.9	26.2	26.8
8x5 #8 Range Nozzle x #5 Spreader Nozzle						8x5 #8 Range Nozzle x #5 Spreader Nozzle					
Flow (gpm)	3.58	3.86	4.13	4.38	4.62	Flow (L/hr)	813	877	938	995	1049
Diameter at 1.5 ft ht (ft)	83	85	86	87	88	Diameter at 0.46 m ht (m)	25.3	25.9	26.2	26.5	26.8
Diameter at 6.0 ft ht (ft)	86	87	88	89	90	Diameter at 1.83 m ht (m)	26.2	26.5	26.8	27.1	27.4
8x6 #8 Range Nozzle x #6 Spreader Nozzle						8x6 #8 Range Nozzle x #6 Spreader Nozzle					
Flow (gpm)	3.84	4.14	4.43	4.70	4.95	Flow (L/hr)	872	940	1006	1067	1124
Diameter at 1.5 ft ht (ft)	83	85	86	87	88	Diameter at 0.46 m ht (m)	25.3	25.9	26.2	26.5	26.8
Diameter at 6.0 ft ht (ft)	86	87	88	89	90	Diameter at 1.83 m ht (m)	26.2	26.5	26.8	27.1	27.4
9x5 #9 Range Nozzle x #5 Spreader Nozzle						9x5 #9 Range Nozzle x #5 Spreader Nozzle					
Flow (gpm)	4.16	4.50	4.81	5.10	5.38	Flow (L/hr)	945	1022	1092	1158	1222
Diameter at 1.5 ft ht (ft)	85	87	88	90	91	Diameter at 0.46 m ht (m)	25.9	26.5	26.8	27.4	27.7
Diameter at 6.0 ft ht (ft)	87	89	90	91	92	Diameter at 1.83 m ht (m)	26.5	27.1	27.4	27.7	28.0
9x6 #9 Range Nozzle x #6 Spreader Nozzle						9x6 #9 Range Nozzle x #6 Spreader Nozzle					
Flow (gpm)	4.41	4.77	5.10	5.41	5.70	Flow (L/hr)	1002	1083	1158	1229	1295
Diameter at 1.5 ft ht (ft)	85	87	88	90	91	Diameter at 0.46 m ht (m)	25.9	26.5	26.8	27.4	27.7
Diameter at 6.0 ft ht (ft)	87	89	90	91	92	Diameter at 1.83 m ht (m)	26.5	27.1	27.4	27.7	28.0
10x5 #10 Range Nozzle x #5 Spreader Nozzle						10x5 #10 Range Nozzle x #5 Spreader Nozzle					
Flow (gpm)	4.97	5.37	5.74	6.09	6.42	Flow (L/hr)	1129	1220	1304	1383	1458
Diameter at 1.5 ft ht (ft)	87	89	90	91	92	Diameter at 0.46 m ht (m)	26.5	27.1	27.4	27.7	28.0
Diameter at 6.0 ft ht (ft)	88	90	92	93	94	Diameter at 1.83 m ht (m)	26.8	27.4	28.0	28.3	28.7

Sprinkler performance may vary with actual field conditions. Stream heights range from 6.0 to 7.5 ft (1.8 to 2.3 m) above nozzle based on pressure and nozzle size. Minimum recommended riser height is 1.5 ft (0.46 m)

40 Series

The Senninger® 40 Series impact sprinklers deliver mid-range flows in comparison to the 30 and 50 Series models.



FEATURES

- Wide range of nozzle and vane combinations for excellent distribution at all pressures
- Built-in hex wrench for easy in-the-field maintenance
- 23° model available with double nozzle
- Two trajectories available:
12° - ideal for under-tree irrigation
23° - for maximum throw on overhead systems
- Connection: 3/4" male NPT (female also available)
- Flow rates: 3.82 to 12.6 gpm (868 to 2862 L/hr)
- Operating pressures: 30 to 60 psi (2.07 to 4.14 bar)

CONVENIENT HAND TIGHT NOZZLES™

No tools required with the easy change/easy clean nozzle and vane combination. Half size and square orifice nozzles also available.



4012-1 SPRINKLER INLET PRESSURE-US	psi							SPRINKLER INLET PRESSURE-METRIC	bar						
	30	35	40	45	50	55	60		2.07	2.41	2.76	3.10	3.45	3.79	4.14
#10 Nozzle - Turquoise (5/32")								#10 Nozzle - Turquoise (3.97 mm)							
Flow (gpm)	3.82	4.13	4.41	4.68	4.93	5.17	5.40	Flow (L/hr)	868	938	1002	1063	1120	1174	1226
Diameter at 1.5 ft ht (ft)	73	77	80	83	86	89	91	Diameter at 0.46 m ht (m)	22.3	23.5	24.4	25.3	26.2	27.1	27.7
#11 Nozzle - Yellow (11/64")								#11 Nozzle - Yellow (4.37 mm)							
Flow (gpm)	4.63	5.00	5.34	5.67	5.98	6.27	6.55	Flow (L/hr)	1052	1136	1213	1288	1358	1424	1488
Diameter at 1.5 ft ht (ft)	76	80	83	86	89	92	94	Diameter at 0.46 m ht (m)	23.2	24.4	25.3	26.2	27.1	28.0	28.7
#12 Nozzle - Red (3/16")								#12 Nozzle - Red (4.76 mm)							
Flow (gpm)	5.52	5.97	6.37	6.76	7.13	7.48	7.81	Flow (L/hr)	1254	1356	1447	1535	1619	1699	1774
Diameter at 1.5 ft ht (ft)	78	82	85	88	91	94	96	Diameter at 0.46 m ht (m)	23.8	25.0	25.9	26.8	27.7	28.7	29.3
#13 Nozzle - White (13/64")								#13 Nozzle - White (5.16 mm)							
Flow (gpm)	6.50	7.02	7.49	7.95	8.38	8.80	9.19	Flow (L/hr)	1476	1594	1701	1806	1903	1999	2087
Diameter at 1.5 ft ht (ft)	80	84	87	90	93	96	98	Diameter at 0.46 m ht (m)	24.4	25.6	26.5	27.4	28.3	29.3	29.9
#14 Nozzle - Blue (7/32")								#14 Nozzle - Blue (5.56 mm)							
Flow (gpm)	7.49	8.09	8.63	9.17	9.66	10.1	10.6	Flow (L/hr)	1701	1837	1960	2083	2194	2294	2408
Diameter at 1.5 ft ht (ft)	82	86	89	93	96	99	101	Diameter at 0.46 m ht (m)	25.0	26.2	27.1	28.3	29.3	30.2	30.8

Sprinkler performance may vary with actual field conditions. Stream heights range from 3.5 to 5.0 ft (1.1 to 1.5 m) above nozzle based on pressure and nozzle size. Minimum recommended riser height is 1.5 ft (0.46 m).

40 Series

4023-1 SPRINKLER INLET PRESSURE-US	psi							SPRINKLER INLET PRESSURE-METRIC	bar						
	30	35	40	45	50	55	60		2.07	2.41	2.76	3.10	3.45	3.79	4.14
#10 Nozzle - Turquoise (5/32")								#10 Nozzle - Turquoise (3.97 mm)							
Flow (gpm)	3.82	4.13	4.41	4.68	4.93	5.17	5.40	Flow (L/hr)	868	938	1002	1063	1120	1174	1226
Diameter at 1.5 ft ht (ft)	86	89	91	93	95	96	97	Diameter at 0.46 m ht (m)	26.2	27.1	27.7	28.3	29.0	29.3	29.6
Diameter at 6.0 ft ht (ft)	92	94	96	97	98	99	100	Diameter at 1.83 m ht (m)	28.0	28.7	29.3	29.6	29.9	30.2	30.5
#11 Nozzle - Yellow (11/64")								#11 Nozzle - Yellow (4.37 mm)							
Flow (gpm)	4.63	5.00	5.34	5.67	5.98	6.27	6.55	Flow (L/hr)	1052	1136	1213	1288	1358	1424	1488
Diameter at 1.5 ft ht (ft)	89	92	94	96	98	99	100	Diameter at 0.46 m ht (m)	27.1	28.0	28.7	29.3	29.9	30.2	30.5
Diameter at 6.0 ft ht (ft)	94	96	98	100	102	103	104	Diameter at 1.83 m ht (m)	28.7	29.3	29.9	30.5	31.1	31.4	31.7
#12 Nozzle - Red (3/16")								#12 Nozzle - Red (4.76 mm)							
Flow (gpm)	5.52	5.97	6.37	6.76	7.13	7.48	7.81	Flow (L/hr)	1254	1356	1447	1535	1619	1699	1774
Diameter at 1.5 ft ht (ft)	92	95	97	99	101	102	103	Diameter at 0.46 m ht (m)	28.0	29.0	29.6	30.2	30.8	31.1	31.4
Diameter at 6.0 ft ht (ft)	97	99	101	103	105	107	108	Diameter at 1.83 m ht (m)	29.6	30.2	30.8	31.4	32.0	32.6	32.9
#13 Nozzle - White (13/64")								#13 Nozzle - White (5.16 mm)							
Flow (gpm)	6.50	7.02	7.49	7.95	8.38	8.80	9.19	Flow (L/hr)	1476	1594	1701	1806	1903	1999	2087
Diameter at 1.5 ft ht (ft)	94	97	99	101	103	104	105	Diameter at 0.46 m ht (m)	28.7	29.6	30.2	30.8	31.4	31.7	32.0
Diameter at 6.0 ft ht (ft)	100	103	106	109	112	115	117	Diameter at 1.83 m ht (m)	30.5	31.4	32.3	33.2	34.1	35.1	35.7
#14 Nozzle - Blue (7/32")								#14 Nozzle - Blue (5.56 mm)							
Flow (gpm)	7.49	8.09	8.63	9.17	9.66	10.1	10.6	Flow (L/hr)	1701	1837	1960	2083	2194	2294	2408
Diameter at 1.5 ft ht (ft)	96	99	101	103	105	106	107	Diameter at 0.46 m ht (m)	29.3	30.2	30.8	31.4	32.0	32.3	32.6
Diameter at 6.0 ft ht (ft)	102	106	110	114	118	122	125	Diameter at 1.83 m ht (m)	31.1	32.3	33.5	34.7	36.0	37.2	38.1

4023-2 SPRINKLER INLET PRESSURE-US	psi							SPRINKLER INLET PRESSURE-METRIC	bar						
	30	35	40	45	50	55	60		2.07	2.41	2.76	3.10	3.45	3.79	4.14
10x6 #10 Range Nozzle x #6 Spreader Nozzle								10x6 #10 Range Nozzle x #6 Spreader Nozzle							
Flow (gpm)	5.25	5.67	6.07	6.43	6.78	7.11	7.43	Flow (L/hr)	1192	1288	1379	1460	1540	1615	1688
Diameter at 1.5 ft ht (ft)	86	89	91	93	95	96	97	Diameter at 0.46 m ht (m)	26.2	27.1	27.7	28.3	29.0	29.3	29.6
Diameter at 6.0 ft ht (ft)	92	94	96	97	98	99	100	Diameter at 1.83 m ht (m)	28.0	28.7	29.3	29.6	29.9	30.2	30.5
11x6 #11 Range Nozzle x #6 Spreader Nozzle								11x6 #11 Range Nozzle x #6 Spreader Nozzle							
Flow (gpm)	6.10	6.59	7.05	7.47	7.88	8.26	8.63	Flow (L/hr)	1385	1497	1601	1697	1790	1876	1960
Diameter at 1.5 ft ht (ft)	89	92	94	96	98	99	100	Diameter at 0.46 m ht (m)	27.1	28.0	28.7	29.3	29.9	30.2	30.5
Diameter at 6.0 ft ht (ft)	94	96	98	100	102	103	104	Diameter at 1.83 m ht (m)	28.7	29.3	29.9	30.5	31.1	31.4	31.7
12x6 #12 Range Nozzle x #6 Spreader Nozzle								12x6 #12 Range Nozzle x #6 Spreader Nozzle							
Flow (gpm)	6.89	7.54	8.07	8.55	9.02	9.46	9.88	Flow (L/hr)	1565	1713	1833	1942	2049	2149	2244
Diameter at 1.5 ft ht (ft)	92	95	97	99	101	102	103	Diameter at 0.46 m ht (m)	28.0	29.0	29.6	30.2	30.8	31.1	31.4
Diameter at 6.0 ft ht (ft)	97	99	101	103	105	107	108	Diameter at 1.83 m ht (m)	29.6	30.2	30.8	31.4	32.0	32.6	32.9
13x6 #13 Range Nozzle x #6 Spreader Nozzle								13x6 #13 Range Nozzle x #6 Spreader Nozzle							
Flow (gpm)	7.93	8.57	9.16	9.72	10.2	10.7	11.2	Flow (L/hr)	1801	1946	2080	2208	2317	2430	2544
Diameter at 1.5 ft ht (ft)	94	97	99	101	103	104	105	Diameter at 0.46 m ht (m)	28.7	29.6	30.2	30.8	31.4	31.7	32.0
Diameter at 6.0 ft ht (ft)	100	103	106	109	112	115	117	Diameter at 1.83 m ht (m)	30.5	31.4	32.3	33.2	34.1	35.1	35.7
14x6 #14 Range Nozzle x #6 Spreader Nozzle								14x6 #14 Range Nozzle x #6 Spreader Nozzle							
Flow (gpm)	8.90	9.62	10.3	10.9	11.5	12.1	12.6	Flow (L/hr)	2021	2185	2339	2476	2612	2748	2862
Diameter at 1.5 ft ht (ft)	96	99	101	103	105	106	107	Diameter at 0.46 m ht (m)	29.3	30.2	30.8	31.4	32.0	32.3	32.6
Diameter at 6.0 ft ht (ft)	102	106	110	114	118	122	125	Diameter at 1.83 m ht (m)	31.1	32.3	33.5	34.7	36.0	37.2	38.1

Sprinkler performance may vary with actual field conditions. Stream heights range from 6.5 to 10.0 ft (2.0 to 3.1 m) above nozzle based on pressure and nozzle size. Minimum recommended riser height is 1.5 ft (0.46 m)

50 Series

The Senninger® 50 Series impact sprinklers deliver higher flows than the 30 or 40 Series models.



FEATURES

- Wide range of nozzle and vane combinations for excellent distribution at all pressures
- Built-in hex wrench for easy in-the-field maintenance
- 23° model available with double nozzle
- Two trajectories:
12° - ideal for under-tree irrigation
23° - maximum throw on overhead systems
- Connections: 3/4" male NPT (female also available)
- Flow rates: 6.5 to 20.1 gpm (1476 to 4565 L/hr)
- Operating pressures: 30 to 65 psi (2.07 to 4.48 bar)

CONVENIENT HAND TIGHT NOZZLES™

No tools required with the easy change/easy clean nozzle and vane combination. Half size and square orifice nozzles also available.

5012-1 SPRINKLER INLET PRESSURE-US	psi								SPRINKLER INLET PRESSURE-METRIC	bar							
	30	35	40	45	50	55	60	65		2.07	2.41	2.76	3.10	3.45	3.79	4.14	4.48
#13 Nozzle - White (13/64")									#13 Nozzle - White (5.16 mm)								
Flow (gpm)	6.50	7.02	7.49	7.95	8.36	8.80	9.19	9.55	Flow (L/hr)	1476	1594	1701	1806	1899	1999	2087	2169
Diameter at 1.5 ft ht (ft)	77	83	89	93	97	100	103	105	Diameter at 0.46 m ht (m)	23.5	25.3	27.1	28.3	29.6	30.5	31.4	32.0
#14 Nozzle - Blue (7/32")									#14 Nozzle - Blue (5.56 mm)								
Flow (gpm)	7.49	8.09	8.63	9.17	9.66	10.1	10.6	11.0	Flow (L/hr)	1701	1837	1960	2083	2194	2294	2408	2498
Diameter at 1.5' ht. (ft.)	79	85	91	95	99	102	105	107	Diameter at 0.46 m ht (m)	24.1	25.9	27.7	29.0	30.2	31.1	32.0	32.6
#15 Nozzle - Dark Brown (15/64")									#15 Nozzle - Dark Brown (5.95 mm)								
Flow (gpm)	8.51	9.19	9.81	10.4	11.0	11.5	12.0	12.5	Flow (L/hr)	1933	2087	2228	2362	2498	2612	2725	2839
Diameter at 1.5 ft ht (ft)	81	87	93	97	101	104	107	109	Diameter at 0.46 m ht (m)	24.7	26.5	28.3	29.6	30.8	31.7	32.6	33.2
#16 Nozzle - Orange (1/4")									#16 Nozzle - Orange (6.35 mm)								
Flow (gpm)	9.63	10.4	11.1	11.8	12.4	13.0	13.6	14.2	Flow (L/hr)	2187	2362	2521	2680	2816	2953	3089	3225
Diameter at 1.5 ft ht (ft)	83	89	95	99	103	106	109	111	Diameter at 0.46 m ht (m)	25.3	27.1	29.0	30.2	31.4	32.3	33.2	33.8
#17 Nozzle - Dark Green (17/64")									#17 Nozzle - Dark Green (6.75 mm)								
Flow (gpm)	10.7	11.6	12.3	13.1	13.8	14.5	15.1	15.7	Flow (L/hr)	2430	2635	2794	2975	3134	3293	3430	3566
Diameter at 1.5 ft ht (ft)	85	91	96	100	105	108	111	113	Diameter at 0.46 m ht (m)	25.9	27.7	29.3	30.5	32.0	32.9	33.8	34.4
#18 Nozzle - Purple (9/32")									#18 Nozzle - Purple (7.14 mm)								
Flow (gpm)	11.9	12.9	13.7	14.6	15.4	16.1	16.8	17.5	Flow (L/hr)	2703	2930	3112	3316	3498	3657	3816	3975
Diameter at 1.5 ft ht (ft)	87	92	97	101	107	110	113	114	Diameter at 0.46 m ht (m)	26.5	28.0	29.6	30.8	32.6	33.5	34.4	34.7

Sprinkler performance may vary with actual field conditions. Stream heights range from 3.5 to 6.0 ft (1.1 to 1.8 m) above nozzle based on pressure and nozzle size. Minimum recommended riser height is 1.5 ft (0.46 m).

50 Series

5023-1 SPRINKLER INLET PRESSURE-US	psi								SPRINKLER INLET PRESSURE-METRIC	bar							
	30	35	40	45	50	55	60	65		2.07	2.41	2.76	3.10	3.45	3.79	4.14	4.48
#13 Nozzle - White (13/64")									#13 Nozzle - White (5.16 mm)								
Flow (gpm)	6.50	7.02	7.49	7.95	8.38	8.80	9.19	9.55	Flow (L/hr)	1476	1594	1701	1806	1903	1999	2087	2169
Diameter at 1.5 ft ht (ft)	92	95	98	100	102	103	104	105	Diameter at 0.46 m ht (m)	28.0	29.0	29.9	30.5	31.1	31.4	31.7	32.0
Diameter at 6.0 ft ht (ft)	99	102	104	106	108	110	112	114	Diameter at 1.83 m ht (m)	30.2	31.1	31.7	32.3	32.9	33.5	34.1	34.7
#14 Nozzle - Blue (7/32")									#14 Nozzle - Blue (5.56 mm)								
Flow (gpm)	7.49	8.09	8.63	9.17	9.66	10.1	10.6	11.0	Flow (L/hr)	1701	1837	1960	2083	2194	2294	2408	2498
Diameter at 1.5 ft ht (ft)	94	98	101	103	105	106	107	108	Diameter at 0.46 m ht (m)	28.7	29.9	30.8	31.4	32.0	32.3	32.6	32.9
Diameter at 6.0 ft ht (ft)	101	104	107	110	112	114	116	118	Diameter at 1.83 m ht (m)	30.8	31.7	32.6	33.5	34.1	34.7	35.4	36.0
#15 Nozzle - Dark Brown (15/64")									#15 Nozzle - Dark Brown (5.95 mm)								
Flow (gpm)	8.51	9.19	9.81	10.4	11.0	11.5	12.0	12.5	Flow (L/hr)	1933	2087	2228	2362	2498	2612	2725	2839
Diameter at 1.5 ft ht (ft)	96	100	103	106	107	108	109	110	Diameter at 0.46 m ht (m)	29.3	30.5	31.4	32.3	32.6	32.9	33.2	33.5
Diameter at 6.0 ft ht (ft)	102	106	109	112	114	116	118	120	Diameter at 1.83 m ht (m)	31.1	32.3	33.2	34.1	34.7	35.4	36.0	36.6
#16 Nozzle - Orange (1/4")									#16 Nozzle - Orange (6.35 mm)								
Flow (gpm)	9.63	10.4	11.1	11.8	12.4	13.0	13.6	14.2	Flow (L/hr)	2187	2362	2521	2680	2816	2953	3089	3225
Diameter at 1.5 ft ht (ft)	98	102	105	108	109	110	111	112	Diameter at 0.46 m ht (m)	29.9	31.1	32.0	32.9	33.2	33.5	33.8	34.1
Diameter at 6.0 ft ht (ft)	103	107	111	114	116	118	120	122	Diameter at 1.83 m ht (m)	31.4	32.6	33.8	34.7	35.4	36.0	36.6	37.2
#17 Nozzle - Dark Green (17/64")									#17 Nozzle - Dark Green (6.75 mm)								
Flow (gpm)	10.7	11.6	12.3	13.1	13.8	14.5	15.1	15.7	Flow (L/hr)	2430	2635	2794	2975	3134	3293	3430	3566
Diameter at 1.5 ft ht (ft)	99	104	107	110	111	112	113	114	Diameter at 0.46 m ht (m)	30.2	31.7	32.6	33.5	33.8	34.1	34.4	34.7
Diameter at 6.0 ft ht (ft)	104	108	112	115	118	120	122	124	Diameter at 1.83 m ht (m)	31.7	32.9	34.1	35.1	36.0	36.6	37.2	37.8
#18 Nozzle - Purple (9/32")									#18 Nozzle - Purple (7.14 mm)								
Flow (gpm)	11.9	12.9	13.7	14.6	15.4	16.1	16.8	17.5	Flow (L/hr)	2703	2930	3112	3316	3498	3657	3816	3975
Diameter at 1.5 ft ht (ft)	100	105	109	112	113	114	115	116	Diameter at 0.46 m ht (m)	30.5	32.0	33.2	34.1	34.4	34.7	35.1	35.4
Diameter at 6.0 ft ht (ft)	105	109	113	116	119	122	124	126	Diameter at 1.83 m ht (m)	32.0	33.2	34.4	35.4	36.3	37.2	37.8	38.4

5023-2 SPRINKLER INLET PRESSURE-US	psi								SPRINKLER INLET PRESSURE-METRIC	bar							
	30	35	40	45	50	55	60	65		2.07	2.41	2.76	3.10	3.45	3.79	4.14	4.48
13x8 #13 Range Nozzle x #8 Spreader Nozzle									13x8 #13 Range Nozzle x #8 Spreader Nozzle								
Flow (gpm)	8.23	8.88	9.50	10.1	10.6	11.1	11.6	12.1	Flow (L/hr)	1869	2017	2158	2294	2408	2521	2635	2748
Diameter at 1.5 ft ht (ft)	92	95	98	100	102	103	104	105	Diameter at 0.46 m ht (m)	28.0	29.0	29.9	30.5	31.1	31.4	31.7	32.0
Diameter at 6.0 ft ht (ft)	99	102	104	106	108	110	112	114	Diameter at 1.83 m ht (m)	30.2	31.1	31.7	32.3	32.9	33.5	34.1	34.7
14x8 #14 Range Nozzle x #8 Spreader Nozzle									14x8 #14 Range Nozzle x #8 Spreader Nozzle								
Flow (gpm)	9.35	10.1	10.8	11.5	12.1	12.7	13.2	13.8	Flow (L/hr)	2124	2294	2453	2612	2748	2884	2998	3134
Diameter at 1.5 ft ht (ft)	94	98	101	103	105	106	107	108	Diameter at 0.46 m ht (m)	28.7	29.9	30.8	31.4	32.0	32.3	32.6	32.9
Diameter at 6.0 ft ht (ft)	101	104	107	110	112	114	116	118	Diameter at 1.83 m ht (m)	30.8	31.7	32.6	33.5	34.1	34.7	35.4	36.0
15x8 #15 Range Nozzle x #8 Spreader Nozzle									15x8 #15 Range Nozzle x #8 Spreader Nozzle								
Flow (gpm)	10.3	11.2	11.9	12.7	13.4	14.0	14.6	15.2	Flow (L/hr)	2339	2544	2703	2884	3043	3180	3316	3452
Diameter at 1.5 ft ht (ft)	96	100	103	106	107	108	109	110	Diameter at 0.46 m ht (m)	29.3	30.5	31.4	32.3	32.6	32.9	33.2	33.5
Diameter at 6.0 ft ht (ft)	102	106	109	112	114	116	118	120	Diameter at 1.83 m ht (m)	31.1	32.3	33.2	34.1	34.7	35.4	36.0	36.6
16x8 #16 Range Nozzle x #8 Spreader Nozzle									16x8 #16 Range Nozzle x #8 Spreader Nozzle								
Flow (gpm)	11.5	12.4	13.3	14.1	14.8	15.5	16.2	16.9	Flow (L/hr)	2612	2816	3021	3202	3361	3520	3679	3838
Diameter at 1.5 ft ht (ft)	98	102	105	108	109	110	111	112	Diameter at 0.46 m ht (m)	29.9	31.1	32.0	32.9	33.2	33.5	33.8	34.1
Diameter at 6.0 ft ht (ft)	103	107	111	114	116	118	120	122	Diameter at 1.83 m ht (m)	31.4	32.6	33.8	34.7	35.4	36.0	36.6	37.2
17x8 #17 Range Nozzle x #8 Spreader Nozzle									17x8 #17 Range Nozzle x #8 Spreader Nozzle								
Flow (gpm)	12.5	13.5	14.4	15.3	16.1	16.9	17.7	18.4	Flow (L/hr)	2839	3066	3271	3475	3657	3838	4020	4179
Diameter at 1.5 ft ht (ft)	99	104	107	110	111	112	113	114	Diameter at 0.46 m ht (m)	30.2	31.7	32.6	33.5	33.8	34.1	34.4	34.7
Diameter at 6.0 ft ht (ft)	104	108	112	115	118	120	122	124	Diameter at 1.83 m ht (m)	31.7	32.9	34.1	35.1	36.0	36.6	37.2	37.8
18x8 #18 Range Nozzle x #8 Spreader Nozzle									18x8 #18 Range Nozzle x #8 Spreader Nozzle								
Flow (gpm)	13.7	14.8	15.8	16.7	17.6	18.5	19.3	20.1	Flow (L/hr)	3112	3361	3589	3793	3997	4202	4384	4565
Diameter at 1.5 ft ht (ft)	100	105	109	112	113	114	115	116	Diameter at 0.46 m ht (m)	30.5	32.0	33.2	34.1	34.4	34.7	35.1	35.4
Diameter at 6.0 ft ht (ft)	105	109	113	116	119	122	124	126	Diameter at 1.83 m ht (m)	32.0	33.2	34.4	35.4	36.3	37.2	37.8	38.4

Sprinkler performance may vary with actual field conditions. Stream heights range from 7.0 to 11.5 ft (2.1 to 3.5 m) above nozzle based on pressure and nozzle size. Minimum recommended riser height is 1.5 ft (0.46 m).

Part-Circle

The Senninger® Part-Circle impact sprinklers allow adjustments to match the desired area of coverage. They are used in agriculture, nurseries, effluent solution disposal, dust suppression and industrial applications.



Part-Circle impact sprinklers can be adjusted to match the desired area of coverage.

FEATURES

- Distributes water in a 60° to 360° adjustable pattern in 5° increments, no tools needed
- Easily convertible to full-circle operation
- Covered reversing mechanism
- 23° nozzle trajectory for maximum radius of throw
- Wide range of nozzle and vane combinations for excellent distribution at all pressures
- Connection: 3/4" male NPT
- Flow range: 2.42 to 16.10 gpm (550 to 3657 L/hr)
- Operating pressures: 30 to 55 psi (2.07 to 3.79 bar)

CONVENIENT HAND TIGHT NOZZLES™



No tools required with the easy change/easy clean nozzle and vane combination. Half size and square orifice nozzles also available.

3123PC SPRINKLER INLET PRESSURE-US	psi						SPRINKLER INLET PRESSURE-METRIC	bar					
	30	35	40	45	50	55		2.07	2.41	2.76	3.10	3.45	3.79
#8 Nozzle - Lavender (1/8")							#8 Nozzle - Lavender (3.18 mm)						
Flow (gpm)	2.42	2.62	2.79	2.97	3.12	3.28	Flow (L/hr)	550	595	634	675	709	745
Radius at 1.5 ft ht (ft)	38	39	40	41	42	42	Radius at 0.46 m ht (m)	12	12	12	12	13	13
Radius at 3.0 ft ht (ft)	40	41	42	42	43	43	Radius at 0.91 m ht (m)	12	12	13	13	13	13
#9 Nozzle - Grey (9/64")							#9 Nozzle - Grey (3.57 mm)						
Flow (gpm)	3.08	3.33	3.56	3.78	3.98	4.18	Flow (L/hr)	700	756	809	859	904	949
Radius at 1.5 ft ht (ft)	40	41	42	43	43	44	Radius at 0.46 m ht (m)	12	12	13	13	13	13
Radius at 3.0 ft ht (ft)	41	43	44	44	45	45	Radius at 0.91 m ht (m)	12	13	13	13	14	14
#10 Nozzle - Turquoise (5/32")							#10 Nozzle - Turquoise (3.97 mm)						
Flow (gpm)	3.82	4.13	4.41	4.68	4.93	5.17	Flow (L/hr)	868	938	1002	1063	1120	1174
Radius at 1.5 ft ht (ft)	41	43	44	45	45	46	Radius at 0.46 m ht (m)	12	13	13	14	14	14
Radius at 3.0 ft ht (ft)	41	44	45	46	46	47	Radius at 0.91 m ht (m)	12	13	14	14	14	14

Sprinkler performance may vary with actual field conditions. Stream heights range from 6.0 to 10.0 ft (1.8 to 3.1 m) above nozzle based on pressure and nozzle size. Minimum recommended riser height is 1.5 ft (0.46 m).

4123PC SPRINKLER INLET PRESSURE-US	psi						SPRINKLER INLET PRESSURE-METRIC	bar					
	30	35	40	45	50	55		2.07	2.41	2.76	3.10	3.45	3.79
#10 Nozzle - Turquoise (5/32")							#10 Nozzle - Turquoise (3.97 mm)						
Flow (gpm)	3.82	4.13	4.41	4.68	4.93	5.17	Flow (L/hr)	868	938	1002	1063	1120	1174
Radius at 1.5 ft ht (ft)	41	43	44	45	45	46	Radius at 0.46 m ht (m)	12	13	13	14	14	14
Radius at 3.0 ft ht (ft)	41	44	45	46	46	47	Radius at 0.91 m ht (m)	12	13	14	14	14	14
#11 Nozzle - Yellow (11/64")							#11 Nozzle - Yellow (4.37 mm)						
Flow (gpm)	4.63	5.00	5.34	5.67	5.98	6.27	Flow (L/hr)	1052	1136	1213	1288	1358	1424
Radius at 1.5 ft ht (ft)	44	45	46	47	48	48	Radius at 0.46 m ht (m)	13	14	14	14	14	15
Radius at 3.0 ft ht (ft)	45	45	47	48	49	49	Radius at 0.91 m ht (m)	14	14	14	15	15	15
#12 Nozzle - Red (3/16")							#12 Nozzle - Red (4.76 mm)						
Flow (gpm)	5.52	5.97	6.37	6.76	7.13	7.48	Flow (L/hr)	1254	1356	1447	1535	1619	1699
Radius at 1.5 ft ht (ft)	45	46	48	49	50	51	Radius at 0.46 m ht (m)	14	14	14	15	15	15
Radius at 3.0 ft ht (ft)	46	47	49	50	51	51	Radius at 0.91 m ht (m)	14	14	15	15	15	16
#13 Nozzle - White (13/64")							#13 Nozzle - White (5.16 mm)						
Flow (gpm)	6.50	7.02	7.49	7.95	8.38	8.80	Flow (L/hr)	1476	1594	1701	1806	1903	1999
Radius at 1.5 ft ht (ft)	45	47	48	50	51	51	Radius at 0.46 m ht (m)	14	14	15	15	15	16
Radius at 3.0 ft ht (ft)	46	48	49	50	51	52	Radius at 0.91 m ht (m)	14	14	15	15	16	16

5123PC SPRINKLER INLET PRESSURE-US	psi						SPRINKLER INLET PRESSURE-METRIC	bar					
	30	35	40	45	50	55		2.07	2.41	2.76	3.10	3.45	3.79
#13 Nozzle - White (13/64")							#13 Nozzle - White (5.16 mm)						
Flow (gpm)	6.50	7.02	7.49	7.95	8.38	8.80	Flow (L/hr)	1476	1594	1701	1806	1903	1999
Radius at 1.5 ft ht (ft)	45	47	48	50	51	51	Radius at 0.46 m ht (m)	14	14	15	15	15	16
Radius at 3.0 ft ht (ft)	46	48	49	50	51	52	Radius at 0.91 m ht (m)	14	14	15	15	16	16
#14 Nozzle - Blue (7/32")							#14 Nozzle - Blue (5.56 mm)						
Flow (gpm)	7.49	8.09	8.63	9.17	9.66	10.10	Flow (L/hr)	1701	1837	1960	2083	2194	2294
Radius at 1.5 ft ht (ft)	46	47	49	50	51	52	Radius at 0.46 m ht (m)	14	14	15	15	16	16
Radius at 3.0 ft ht (ft)	47	49	51	52	53	54	Radius at 0.91 m ht (m)	14	15	16	16	16	16
#15 Nozzle - Dark Brown (15/64")							#15 Nozzle - Dark Brown (5.95 mm)						
Flow (gpm)	8.51	9.19	9.81	10.4	11.0	11.5	Flow (L/hr)	1933	2087	2228	2362	2498	2612
Radius at 1.5 ft ht (ft)	46	48	50	51	52	53	Radius at 0.46 m ht (m)	14	15	15	16	16	16
Radius at 3.0 ft ht (ft)	48	50	52	53	54	56	Radius at 0.91 m ht (m)	15	15	16	16	16	17
#16 Nozzle - Orange (1/4")							#16 Nozzle - Orange (6.35 mm)						
Flow (gpm)	9.63	10.4	11.1	11.8	12.4	13.0	Flow (L/hr)	2187	2362	2521	2680	2816	2953
Radius at 1.5 ft ht (ft)	47	50	51	53	54	55	Radius at 0.46 m ht (m)	14	15	16	16	16	17
Radius at 3.0 ft ht (ft)	48	51	53	55	56	57	Radius at 0.91 m ht (m)	15	16	16	17	17	17
#17 Nozzle - Dark Green (17/64")							#17 Nozzle - Dark Green (6.75 mm)						
Flow (gpm)	10.7	11.6	12.3	13.1	13.8	14.5	Flow (L/hr)	2430	2635	2794	2975	3134	3293
Radius at 1.5 ft ht (ft)	47	50	52	54	55	56	Radius at 0.46 m ht (m)	14	15	16	16	17	17
Radius at 3.0 ft ht (ft)	49	51	54	56	57	58	Radius at 0.91 m ht (m)	15	16	16	17	17	18
#18 Nozzle - Purple (9/32")							#18 Nozzle - Purple (7.14 mm)						
Flow (gpm)	11.9	12.9	13.7	14.6	15.4	16.1	Flow (L/hr)	2703	2930	3112	3316	3498	3657
Radius at 1.5 ft ht (ft)	47	50	53	55	56	57	Radius at 0.46 m ht (m)	14	15	16	17	17	17
Radius at 3.0 ft ht (ft)	49	52	54	56	58	59	Radius at 0.91 m ht (m)	15	16	16	17	18	18

Sprinkler performance may vary with actual field conditions. Stream heights range from 6.0 to 10.0 ft (1.8 to 3.1 m) above nozzle based on pressure and nozzle size. Minimum recommended riser height is 1.5 ft (0.46 m).

70 Series



The 70 Series full-circle impacts distribute water at higher flows over a large diameter.

FEATURES

- Double nozzle and spread drive models available
- Outlasts and costs less than brass sprinklers
- Built-in hex wrench for easy in-the-field maintenance
- Connections: 1" male NPT, 1" male BSPT also available
- Flow rates: 8.66 to 39.10 gpm (1967 to 8881 L/hr)
- Operating pressures: 40 to 70 psi (2.76 to 4.83 bar)

BSPT CONNECTION ALSO AVAILABLE

7025RD-1 SPRINKLER INLET PRESSURE-US	psi				SPRINKLER INLET PRESSURE-METRIC	bar			
	40	50	60	70		2.76	3.45	4.14	4.83
#14 Nozzle (7/32")					#14 Nozzle (5.56 mm)				
Flow (gpm)	8.66	9.69	10.6	11.5	Flow (L/hr)	1967	2201	2408	2612
Diameter at 1.5 ft ht (ft)	111	115	119	123	Diameter at 0.46 m ht (m)	33.8	35.1	36.3	37.5
Diameter at 6.0 ft ht (ft)	118	124	128	130	Diameter at 1.83 m ht (m)	36.0	37.8	39.0	39.6
#16 Nozzle (1/4")					#16 Nozzle (6.35 mm)				
Flow (gpm)	11.4	12.8	14.0	15.1	Flow (L/hr)	2589	2907	3180	3430
Diameter at 1.5 ft ht (ft)	117	123	129	133	Diameter at 0.46 m ht (m)	35.7	37.5	39.3	40.5
Diameter at 6.0 ft ht (ft)	126	131	136	138	Diameter at 1.83 m ht (m)	38.4	39.9	41.5	42.1
#18 Nozzle (9/32")					#18 Nozzle (7.14 mm)				
Flow (gpm)	14.2	15.9	17.4	18.8	Flow (L/hr)	3225	3611	3952	4270
Diameter at 1.5 ft ht (ft)	124	129	139	144	Diameter at 0.46 m ht (m)	37.8	39.3	42.4	43.9
Diameter at 6.0 ft ht (ft)	132	137	144	147	Diameter at 1.83 m ht (m)	40.2	41.8	43.9	44.8
#20 Nozzle (5/16")					#20 Nozzle (7.94 mm)				
Flow (gpm)	17.1	19.2	21.0	22.7	Flow (L/hr)	3884	4361	4770	5156
Diameter at 1.5 ft ht (ft)	130	137	146	153	Diameter at 0.46 m ht (m)	39.6	41.8	44.5	46.6
Diameter at 6.0 ft ht (ft)	137	143	151	155	Diameter at 1.83 m ht (m)	41.8	43.6	46.0	47.2
#22 Nozzle (11/32")					#22 Nozzle (8.73 mm)				
Flow (gpm)	20.5	22.9	25.1	27.1	Flow (L/hr)	4656	5201	5701	6155
Diameter at 1.5 ft ht (ft)	133	148	157	162	Diameter at 0.46 m ht (m)	40.5	45.1	47.9	49.4
Diameter at 6.0 ft ht (ft)	141	150	159	164	Diameter at 1.83 m ht (m)	43.0	45.7	48.5	50.0
#24 Nozzle (3/8")					#24 Nozzle (9.53 mm)				
Flow (gpm)	23.9	26.7	29.3	31.6	Flow (L/hr)	5428	6064	6655	7177
Diameter at 1.5 ft ht (ft)	138	151	160	169	Diameter at 0.46 m ht (m)	42.1	46.0	48.8	51.5
Diameter at 6.0 ft ht (ft)	145	155	164	170	Diameter at 1.83 m ht (m)	44.2	47.2	50.0	51.8

Sprinkler performance may vary with actual field conditions. Diameters shown are for standard straight bore nozzles and stream straightening vanes. Other nozzles and/or vane combinations are available. Consult factory for specific performance data. Stream heights range from 8.5 to 15.5 ft (2.6 to 4.7 m) above nozzle based on pressure and nozzle size. Minimum recommended riser height is 1.5 ft (0.46 m).

70 Series

7025RD-2 SPRINKLER INLET PRESSURE-US	psi				SPRINKLER INLET PRESSURE-METRIC	bar			
	40	50	60	70		2.76	3.45	4.14	4.83
14x8 #14 Range Nozzle x #8 Spreader Nozzle					14x8 #14 Range Nozzle x #8 Spreader Nozzle				
Flow (gpm)	11.4	12.7	13.9	15.1	Flow (L/hr)	2589	2884	3157	3430
Diameter at 1.5 ft ht (ft)	111	115	119	123	Diameter at 0.46 m ht (m)	33.8	35.1	36.3	37.5
Diameter at 6.0 ft ht (ft)	118	124	128	130	Diameter at 1.83 m ht (m)	36.0	37.8	39.0	39.6
16x8 #16 Range Nozzle x #8 Spreader Nozzle					16x8 #16 Range Nozzle x #8 Spreader Nozzle				
Flow (gpm)	14.3	16.0	17.5	18.9	Flow (L/hr)	3248	3634	3975	4293
Diameter at 1.5 ft ht (ft)	117	123	129	133	Diameter at 0.46 m ht (m)	35.7	37.5	39.3	40.5
Diameter at 6.0 ft ht (ft)	126	131	136	138	Diameter at 1.83 m ht (m)	38.4	39.9	41.5	42.1
18x8 #18 Range Nozzle x #8 Spreader Nozzle					18x8 #18 Range Nozzle x #8 Spreader Nozzle				
Flow (gpm)	17.0	19.0	20.8	22.5	Flow (L/hr)	3861	4315	4724	5110
Diameter at 1.5 ft ht (ft)	124	129	139	144	Diameter at 0.46 m ht (m)	37.8	39.3	42.4	43.9
Diameter at 6.0 ft ht (ft)	132	137	144	147	Diameter at 1.83 m ht (m)	40.2	41.8	43.9	44.8
18x10 #18 Range Nozzle x #10 Spreader Nozzle					18x10 #18 Range Nozzle x #10 Spreader Nozzle				
Flow (gpm)	18.2	20.3	22.3	24.0	Flow (L/hr)	4134	4611	5065	5451
Diameter at 1.5 ft ht (ft)	124	129	139	144	Diameter at 0.46 m ht (m)	37.8	39.3	42.4	43.9
Diameter at 6.0 ft ht (ft)	132	137	144	147	Diameter at 1.83 m ht (m)	40.2	41.8	43.9	44.8
20x10 #20 Range Nozzle x #10 Spreader Nozzle					20x10 #20 Range Nozzle x #10 Spreader Nozzle				
Flow (gpm)	20.9	23.4	25.7	27.7	Flow (L/hr)	4747	5315	5837	6291
Diameter at 1.5 ft ht (ft)	130	137	146	153	Diameter at 0.46 m ht (m)	39.6	41.8	44.5	46.6
Diameter at 6.0 ft ht (ft)	137	143	151	155	Diameter at 1.83 m ht (m)	41.8	43.6	46.0	47.2
20x12 #20 Range Nozzle x #12 Spreader Nozzle					20x12 #20 Range Nozzle x #12 Spreader Nozzle				
Flow (gpm)	22.8	25.5	27.9	30.2	Flow (L/hr)	5178	5792	6337	6859
Diameter at 1.5 ft ht (ft)	130	137	146	153	Diameter at 0.46 m ht (m)	39.6	41.8	44.5	46.6
Diameter at 6.0 ft ht (ft)	137	143	151	155	Diameter at 1.83 m ht (m)	41.8	43.6	46.0	47.2
22x10 #22 Range Nozzle x #10 Spreader Nozzle					22x10 #22 Range Nozzle x #10 Spreader-Nozzle				
Flow (gpm)	24.5	27.4	30.0	32.4	Flow (L/hr)	5565	6223	6814	7359
Diameter at 1.5 ft ht (ft)	133	148	157	162	Diameter at 0.46 m ht (m)	40.5	45.1	47.9	49.4
Diameter at 6.0 ft ht (ft)	141	150	159	164	Diameter at 1.83 m ht (m)	43.0	45.7	48.5	50.0
22x12 #22 Range Nozzle x #12 Spreader Nozzle					22x12 #22 Range Nozzle x #12 Spreader Nozzle				
Flow (gpm)	26.3	29.4	33.6	34.8	Flow (L/hr)	5973	6677	7631	7904
Diameter at 1.5 ft ht (ft)	133	148	157	162	Diameter at 0.46 m ht (m)	40.5	45.1	47.9	49.4
Diameter at 6.0 ft ht (ft)	141	150	159	164	Diameter at 1.83 m ht (m)	43.0	45.7	48.5	50.0
24x12 #24 Range Nozzle x #12 Spreader Nozzle					24x12 #24 Range Nozzle x #12 Spreader Nozzle				
Flow (gpm)	29.5	33.0	36.2	39.1	Flow (L/hr)	6700	7495	8222	8881
Diameter at 1.5 ft ht (ft)	138	151	160	169	Diameter at 0.46 m ht (m)	42.1	46.0	48.8	51.5
Diameter at 6.0 ft ht (ft)	145	155	164	170	Diameter at 1.83 m ht (m)	44.2	47.2	50.0	51.8

Sprinkler performance may vary with actual field conditions. Diameters shown are for standard straight bore nozzles and stream straightening vanes. Other nozzles and/or vane combinations are available; Consult factory for specific performance data. Stream heights range from 8.5 to 15.5 ft. (2.6 to 4.7 m) above nozzle based on pressure and nozzle size. Minimum recommended riser height is 1.5 ft. (0.46 m).

80 Series



The 80 Series are the largest Senninger® impact sprinklers. They are designed for maximum efficiency at high flows.

BSPT CONNECTION ALSO AVAILABLE

8025HR-1 SPRINKLER INLET PRESSURE-US	psi				SPRINKLER INLET PRESSURE-METRIC	bar			
	40	50	60	70		2.76	3.45	4.14	4.83
#24 Nozzle (3/8")					#24 Nozzle (9.53 mm)				
Flow (gpm)	25.2	28.2	30.9	34.5	Flow (L/hr)	5724	6405	7018	7563
Diameter at 1.5 ft ht (ft)	134	144	154	159	Diameter at 0.46 m ht (m)	40.8	43.9	46.9	48.5
Diameter at 6.0 ft ht (ft)	152	159	164	168	Diameter at 1.83 m ht (m)	46.3	48.5	50.0	51.2
#26 Nozzle (13/32")					#26 Nozzle (10.32 mm)				
Flow (gpm)	29.3	32.7	35.9	38.7	Flow (L/hr)	6655	7427	8154	8790
Diameter at 1.5 ft ht (ft)	142	152	161	166	Diameter at 0.46 m ht (m)	43.3	46.3	49.1	50.6
Diameter at 6.0 ft ht (ft)	157	164	169	173	Diameter at 1.83 m ht (m)	47.9	50.0	51.5	52.7
#28 Nozzle (7/16")					#28 Nozzle (11.11 mm)				
Flow (gpm)	33.9	38.0	41.6	44.9	Flow (L/hr)	7700	8631	9448	10198
Diameter at 1.5 ft ht (ft)	148	157	166	171	Diameter at 0.46 m ht (m)	45.1	47.9	50.6	52.1
Diameter at 6.0 ft ht (ft)	161	168	173	177	Diameter at 1.83 m ht (m)	49.1	51.2	52.7	53.9
#30 Nozzle (15/32")					#30 Nozzle (11.91 mm)				
Flow (gpm)	38.6	43.1	47.2	51.0	Flow (L/hr)	8767	9789	10720	11583
Diameter at 1.5 ft ht (ft)	153	162	170	175	Diameter at 0.46 m ht (m)	46.6	49.4	51.8	53.3
Diameter at 6.0 ft ht (ft)	165	172	177	181	Diameter at 1.83 m ht (m)	50.3	52.4	53.9	55.2
#32 Nozzle (1/2")					#32 Nozzle (12.7 mm)				
Flow (gpm)	43.9	49.0	53.7	58.0	Flow (L/hr)	9971	11129	12197	13173
Diameter at 1.5 ft ht (ft)	156	165	173	179	Diameter at 0.46 m ht (m)	47.5	50.3	52.7	54.6
Diameter at 6.0 ft ht (ft)	169	176	181	185	Diameter at 1.83 m ht (m)	51.5	53.6	55.2	56.4
#34 Nozzle (17/32")					#34 Nozzle (13.49 mm)				
Flow (gpm)	49.5	55.4	60.7	65.5	Flow (L/hr)	11243	12583	13786	14877
Diameter at 1.5 ft ht (ft)	159	168	176	183	Diameter at 0.46 m ht (m)	48.5	51.2	53.6	55.8
Diameter at 6.0 ft ht (ft)	172	179	184	188	Diameter at 1.83 m ht (m)	52.4	54.6	56.1	57.3
#36 Nozzle (9/16")					#36 Nozzle (14.29 mm)				
Flow (gpm)	55.5	62.1	68.0	73.5	Flow (L/hr)	12605	14104	15444	16694
Diameter at 1.5 ft ht (ft)	161	170	178	187	Diameter at 0.46 m ht (m)	49.1	51.8	54.3	57.0
Diameter at 6.0 ft ht (ft)	175	182	187	191	Diameter at 1.83 m ht (m)	53.3	55.5	57.0	58.2
#38 Nozzle (19/32")					#38 Nozzle (15.08 mm)				
Flow (gpm)	59.9	66.9	73.3	79.2	Flow (L/hr)	13605	15195	16648	17988
Diameter at 1.5 ft ht (ft)	163	172	180	190	Diameter at 0.46 m ht (m)	49.7	52.4	54.9	57.9
Diameter at 6.0 ft ht (ft)	178	185	190	194	Diameter at 1.83 m ht (m)	54.3	56.4	57.9	59.1
#40 Nozzle (5/8")					#40 Nozzle (15.88 mm)				
Flow (gpm)	67.1	75.0	82.1	88.7	Flow (L/hr)	15240	17034	18647	20146
Diameter at 1.5 ft ht (ft)	165	174	182	192	Diameter at 0.46 m ht (m)	50.3	53.0	55.5	58.5
Diameter at 6.0 ft ht (ft)	180	187	192	196	Diameter at 1.83 m ht (m)	54.9	57.0	58.5	59.7

Sprinkler performance may vary with actual field conditions. Diameters shown are for standard straight bore nozzles and stream straightening vanes. Other nozzles and/or vane combinations are available. Consult factory for specific performance data. Stream heights range from 12.5 to 28.0 ft (3.8 to 8.5 m) above nozzle based on pressure and nozzle size. Minimum recommended riser height is 1.5 ft (0.46 m).

80 Series

FEATURES

- Single and double nozzle designs available
- Double nozzle available in range or spreader drive
- Outlasts and costs less than brass sprinklers
- Connections: 1 ¼" male NPT, 1 ½" male NPT, and 1 ¼" male BSPT
- Flow rates: 25.2 to 103.2 gpm (5724 to 23439 L/hr)
- Operating pressures: 40 to 70 psi (2.76 to 4.83 bar)
- Built-in hex wrench for easy in-the-field maintenance



8025-SD: The Booster Tube provides a 5 to 10% increased radius of throw over range nozzle performance. Consult factory for specific performance data. Available only on 8025 Spreader Drive double nozzle models.

8025HR-2 SPRINKLER INLET PRESSURE-US	psi				SPRINKLER INLET PRESSURE-METRIC	bar			
	40	50	60	70		2.76	3.45	4.14	4.83
26X14 #26 Range Nozzle x #14 Spreader Nozzle					26x14 #26 Range Nozzle x #14 Spreader Nozzle				
Flow (gpm)	39.4	44.0	48.2	52.1	Flow (L/hr)	8949	9993	10947	11833
Diameter at 1.5 ft ht (ft)	142	152	161	166	Diameter at 0.46 m ht (m)	43.3	46.3	49.1	50.6
Diameter at 6.0 ft ht (ft)	157	164	169	173	Diameter at 1.83 m ht (m)	47.9	50.0	51.5	52.7
28x14 #28 Range Nozzle x #14 Spreader Nozzle					28x14 #28 Range Nozzle x #14 Spreader Nozzle				
Flow (gpm)	42.0	46.9	51.4	55.6	Flow (L/hr)	9539	10652	11674	12628
Diameter at 1.5 ft ht (ft)	148	157	166	171	Diameter at 0.46 m ht (m)	45.1	47.9	50.6	52.1
Diameter at 6.0 ft ht (ft)	161	168	173	177	Diameter at 1.83 m ht (m)	49.1	51.2	52.7	53.9
30x14 #30 Range Nozzle x #14 Spreader Nozzle					30x14 #30 Range Nozzle x #14 Spreader Nozzle				
Flow (gpm)	45.9	51.4	56.3	60.8	Flow (L/hr)	10425	11674	12787	13809
Diameter at 1.5 ft ht (ft)	153	162	170	175	Diameter at 0.46 m ht (m)	46.6	49.4	51.8	53.3
Diameter at 6.0 ft ht (ft)	165	172	177	181	Diameter at 1.83 m ht (m)	50.3	52.4	53.9	55.2
32x16 #32 Range Nozzle x #16 Spreader Nozzle					32x16 #32 Range Nozzle x #16 Spreader Nozzle				
Flow (gpm)	53.7	60.0	65.8	71.0	Flow (L/hr)	12197	13627	14945	16126
Diameter at 1.5 ft ht (ft)	156	165	173	179	Diameter at 0.46 m ht (m)	47.5	50.3	52.7	54.6
Diameter at 6.0 ft ht (ft)	169	176	181	185	Diameter at 1.83 m ht (m)	51.5	53.6	55.2	56.4
34x16 #34 Range Nozzle x #16 Spreader Nozzle					34x16 #34 Range Nozzle x #16 Spreader Nozzle				
Flow (gpm)	59.2	66.2	72.5	78.3	Flow (L/hr)	13446	15036	16467	17784
Diameter at 1.5 ft ht (ft)	159	168	176	183	Diameter at 0.46 m ht (m)	48.5	51.2	53.6	55.8
Diameter at 6.0 ft ht (ft)	172	179	184	188	Diameter at 1.83 m ht (m)	52.4	54.6	56.1	57.3
36x16 #36 Range Nozzle x #16 Spreader Nozzle					36x16 #36 Range Nozzle x #16 Spreader Nozzle				
Flow (gpm)	65.1	72.7	79.7	86.1	Flow (L/hr)	14786	16512	18102	19555
Diameter at 1.5 ft ht (ft)	161	170	178	187	Diameter at 0.46 m ht (m)	49.1	51.8	54.3	57.0
Diameter at 6.0 ft ht (ft)	175	182	187	191	Diameter at 1.83 m ht (m)	53.3	55.5	57.0	58.2
38x18 #38 Range Nozzle x #18 Spreader Nozzle					38x18 #38 Range Nozzle x #18 Spreader Nozzle				
Flow (gpm)	71.7	80.1	87.8	94.9	Flow (L/hr)	16285	18193	19942	21554
Diameter at 1.5 ft ht (ft)	163	172	180	190	Diameter at 0.46 m ht (m)	49.7	52.4	54.9	57.9
Diameter at 6.0 ft ht (ft)	178	185	190	194	Diameter at 1.83 m ht (m)	54.3	56.4	57.9	59.1
40x18 #40 Range Nozzle #18 Spreader Nozzle					40x18 #40 Range Nozzle x #18 Spreader Nozzle				
Flow (gpm)	78.0	87.2	95.6	103.2	Flow (L/hr)	17716	19805	21713	23439
Diameter at 1.5 ft ht (ft)	165	174	182	192	Diameter at 0.46 m ht (m)	50.3	53.0	55.5	58.5
Diameter at 6.0 ft ht (ft)	180	187	192	196	Diameter at 1.83 m ht (m)	54.9	57.0	58.5	59.7

Sprinkler performance may vary with actual field conditions. Diameters shown are for standard straight bore nozzles and stream straightening vanes. Other nozzles and/or vane combinations are available. Consult factory for specific performance data. Stream heights range from 12.5 to 28.0 ft (3.8 to 8.5 m) above nozzle based on pressure and nozzle size. Minimum recommended riser height is 1.5 ft (0.46 m).

Riser Adapter Assemblies

RISER ADAPTER ASSEMBLIES

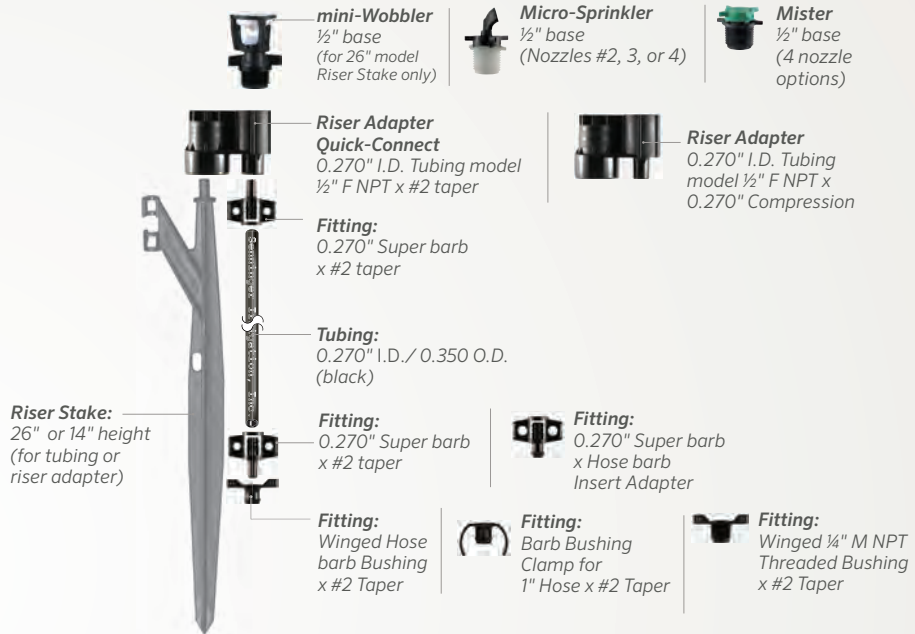

Components are also available for 0.345" tubing.

RISER STAKE

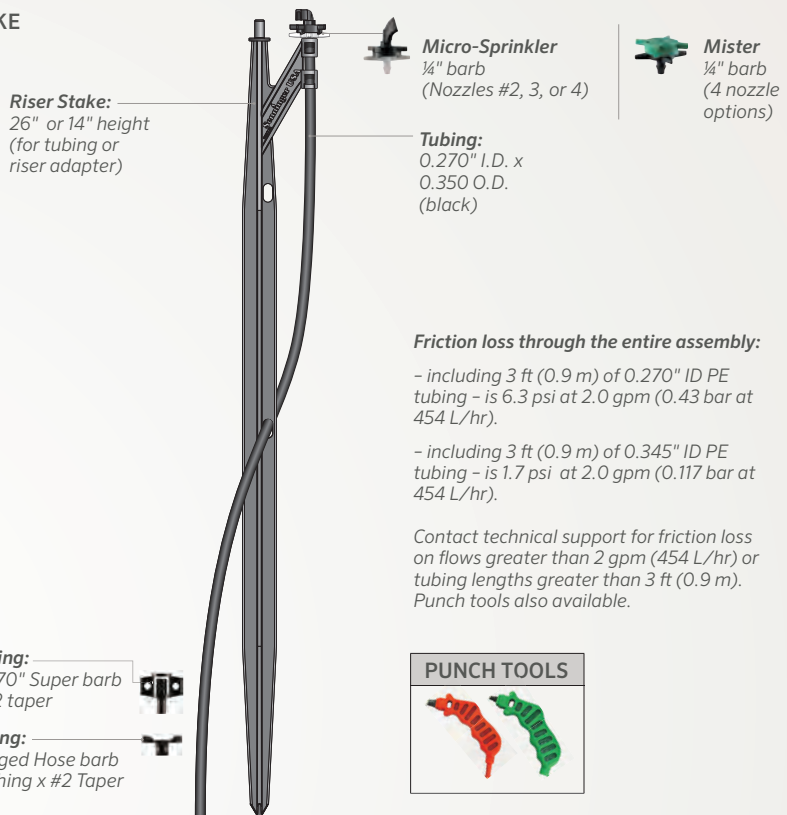

Assemblies **Drop Adapter**

The Senninger® Drop Assembly is simple, fast and economical to install. It is available as an assembly or individual components.



DROP ASSEMBLIES



Insert Adapter
0.345"
Super Barb
x Hose Barb



Fitting:
0.345"
Super Barb
x 1/2" F /
3/4" M Slip



Fitting:
0.345"
Super Barb
x 1/2" M NPT



Tubing:
0.345" I.D./
0.455 O.D.
(black)



Fitting:
0.345" Super Barb
x 1/2" F / 3/4" M Slip



Tubing:
1/2" PVC
10" Length



PVC Connector:
1/2" F Slip x 1/2" F NPT



mini-Wobbler
1/2" base



Mister
1/2" base
(4 nozzle
options)



Micro-Sprinkler
1/2" base
(Nozzles
#3, 4, 5 or 6)



Fogger
1/2" base

Consider friction loss through the tubing and components when designing for optimum performance. Punch tools also available.

Components are also available for 0.270" tubing.

Drain Stop Plus™

The Senninger® Drain Stop Plus™ helps prevent drainage from overhead irrigation applicators. This keeps supply lines full allowing for faster start-ups and protects plants below.

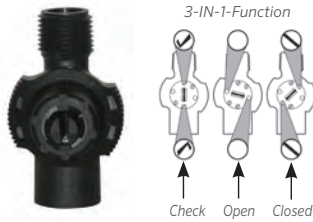

FEATURES

- Unique 3-mode design – open, check, and closed
- Easy clean feature – device and applicator remain in place and a simple twist releases bonnet for debris removal
- Connection: 1/2" male NPT inlet x 1/2" female NPT outlet
- Can be used directly with any 1/2" male NPT base applicator
- Low friction loss – less than 4.25 psi total loss through device at 5 gpm (0.29 bar at 1136 L/hr)
- Minimum opening pressure: 22 psi (1.52 bar), Minimum closing pressure: 6.5 psi (0.45 bar)
- Maximum operating pressure: 50 psi (3.45 bar)
- Flow: 0.25 to 5 gpm (57 to 1136 L/hr)

Fittings & Couplings

Senninger fittings and couplings help facilitate irrigation installations.



FEATURES

- Over 20 different models (*See the Senninger Price List*)
- Threaded, slip and quick-connect configurations available
- Constructed using engineering grade thermoplastic

Quick-Connect Coupling

The Senninger® Quick-Connect Couplings help reduce material costs for irrigation systems. By connecting small diameter pipes, laterals become easier to transport. This is ideal for high rotation crops and field work.



TWO PIECE HOUSING THAT LOCKS TIGHTLY

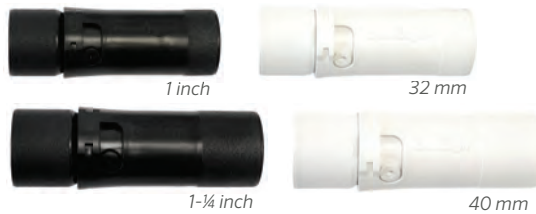

INSTALLATION RECOMMENDATIONS

Apply glue to the outside of the pipe before inserting upper or lower housings. Once glue is dry, connect housings together by inserting the button on the lower housing into the tabbed area of the upper housing. Twist to lock.

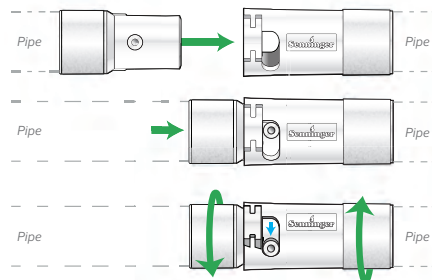

FIELD INSTALLATION

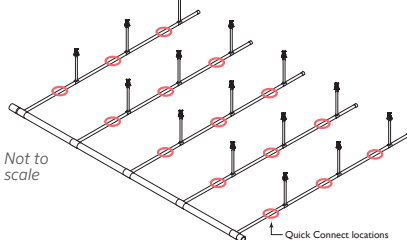

The Senninger Quick-Connect Couplings make it easy to disassemble the system in manageable sections.

FEATURES:

- Lightweight for easy portability
- Virtually leak-proof connection
- Four Models: 1-inch, 1 ¼-inch, 32 mm and 40 mm
- Constructed out of UV resistant thermoplastics

DESIGN CRITERIA

Pipe Diameter	Maximum Pressure	Part Number
1 inch	100 psi (7.0 bar)	QCPLASM4
1-1/4 inch	100 psi (7.0 bar)	QCPLASM5
32 mm	100 psi (7.0 bar)	QCPLASM32MM
40 mm	100 psi (7.0 bar)	QCPLASM40MM

Also available as separate components
(See the Senninger Price List)



Comparisons

Uncontrolled pressure fluctuations in irrigation systems result in unwanted flow deviations and over- and under-watering. These fluctuations occur with activation of different zones, variations in field elevation, or changes in water supply. Proper use of pressure regulators helps maintain the overall efficiency of an irrigation system. Pressure regulators are available in a variety of models to match specific flow and pressure needs.



MPR



PRLG



PRL



PSR™2



**FILTER
REGULATOR**



PMR-MF



PR-HF



PRU



PRLV



PRXF-LV

MODELS	Flow Range	Preset Operating Pressure	Maximum Inlet Pressure	Inlet Sizes	Outlet Sizes
MPR	0.5 - 3.5 gpm (114 - 804 L/hr)	15 - 40 psi (1.0 - 2.8 bar)	80 psi (5.5 bar)	½" M NPT	½" F NPT
PRLG	0.5 - 7 gpm (114 - 1590 L/hr)	10 - 40 psi (0.69 - 2.76 bar)	120 psi (8.27 bar)	¾" F hose, ¾" F NPT	¾" M hose, ¾" M NPT
PRL	0.5 - 8 gpm (114 - 1817 L/hr)	6 - 40 psi (0.41 - 2.76 bar)	120 psi (8.27 bar)	¾" F NPT, ¾" F hose	¾" F NPT
PSR2	0.5 - 15 gpm (114 - 3407 L/hr)	6 - 50 psi (0.41 - 3.45 bar)	130 psi (8.96 bar)	¾" F NPT	¾" F NPT
FILTER REGULATOR	0.5 - 15 gpm (114 - 3407 L/hr)	6 - 20 psi (0.41 - 1.38 bar)	100 psi (6.89 bar)	¾" M NPT	¾" F NPT
PMR-MF	2 - 20 gpm (454 - 4542 L/hr)	6 - 60 psi (0.41 - 4.14 bar)	140 psi (9.65 bar)	¾" F NPT, 1" F NPT, 1" F BSPT	¾" F NPT, 1" F NPT, 1" F BSPT
PR-HF	10 - 32 gpm (2271 - 7268 L/hr)	10 - 50 psi (0.69 - 3.45 bar)	130 psi (8.96 bar)	1 ¼" F NPT, 1 ¼" F BSPT	1" F NPT, 1 ¼" F NPT, 1" F BSPT, 1 ¼" F BSPT
PRU	20 - 100 gpm (4542 - 22713 L/hr)	10 - 60 psi (0.69 - 4.14 bar)	140 psi (9.65 bar)	2" F NPT, 2" F BSPT	2" F NPT, 2" F BSPT
PRLV	Max: 18 gpm (Max: 4088 L/hr)	10 - 60 psi (0.69 - 4.14 bar)	125 psi (8.62 bar)	¾" F NPT, 1" F NPT	¾" F NPT, 1" F NPT
PRXF-LV	Max: 75 gpm (Max: 17034 L/hr)	20 - 60 psi (1.38 - 4.14 bar)	125 psi (8.62 bar)	3" F slip	3" F slip

MPR

NEW!



The MPR (Mini Pressure Regulator) is an economical solution to help reduce excessive pressure. It reduces flow fluctuations so that each sprinkler performs consistently and helps reduce overwatering throughout the irrigation zone, including changing elevations and long lateral runs.



FEATURES

- Designed for use immediately beneath the sprinkler
- Maintains the sprinkler's designed flow to +/-10% of nominal flow
- Allows pressure regulation on sprinklers along laterals or mainlines with up to 115 ft (35 m) elevation change.
- Senninger® pressure regulators are available with models for a wide range of flows

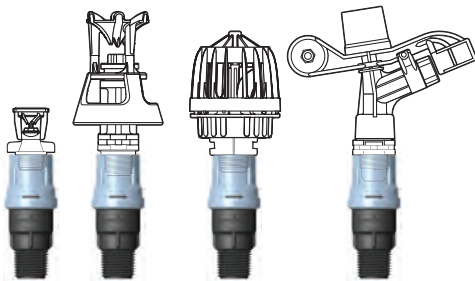
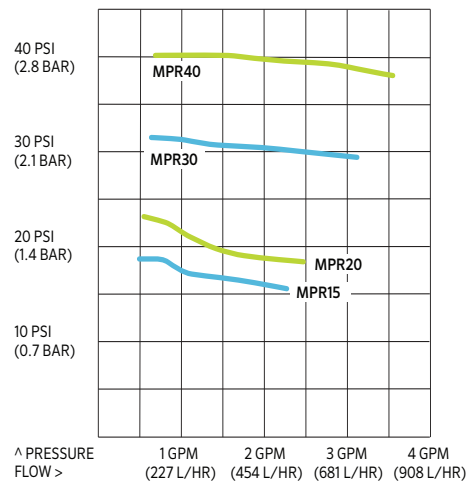

Sprinkler	Nozzles	Model MPR
mini-Wobbler™	#4 - #8 nozzles	15 or 20 psi (1.0 or 1.4 bar)
Xcel-Wobbler™	#6 - #9 nozzles	20 psi (1.4 bar)
Smooth Drive™	#6 - #8 nozzles	30 or 40 psi (2.1 or 2.8 bar)
20 Series Impacts	#6 - #9 nozzles	30 or 40 psi (2.1 or 2.8 bar)

MPR DESIGN CRITERIA	Preset Outlet Pressure	Maximum Inlet Pressure	Flow Range		Inlet Sizes	Outlet Sizes
			gpm	L/hr		
MPR152M2F	15 psi (1.0 bar)	45 psi (3.1 bar)	0.5 - 2.3 gpm	114 - 513 L/hr	½" M NPT	½" F NPT
MPR202M2F	20 psi (1.4 bar)	50 psi (3.5 bar)	0.5 - 2.5 gpm	114 - 513 L/hr	½" M NPT	½" F NPT
MPR302M2F	30 psi (2.1 bar)	60 psi (4.1 bar)	0.6 - 3.1 gpm	136 - 704 L/hr	½" M NPT	½" F NPT
MPR402M2F	40 psi (2.8 bar)	80 psi (5.5 bar)	0.7 - 3.5 gpm	159 - 804 L/hr	½" M NPT	½" F NPT

The pressure regulator shall maintain the predetermined pressure provided that the inlet pressure is at least 5 psi (0.3 bar) above the expected outlet pressure, but not exceeding the maximum inlet pressure as shown in this chart.

CAUTION: Always install downstream from all shut-off valves. Recommended for outdoor use only. Not NSF certified.



PRLG (Pressure Regulator Landscape Grade) is ideal for installations requiring lower flows of 0.5 to 7.0 gpm (114 to 1590 L/hr). It is ideal for irrigation systems connected to hose bibb faucets or other lawn and landscape applications.

FEATURES

- Senninger® regulators maintain a constant preset outlet pressure with varying inlet pressures, which alleviates pressure differences that can cause an applicator’s area of coverage to change.
- Pressure tested, to ensure quality and performance
- Very low hysteresis and friction losses
- Can be installed above or below ground
- Patented tamper-proof design
- No external metal parts for excellent corrosion resistance



PRLG DESIGN CRITERIA	Preset Outlet Pressure	Maximum Inlet Pressure	Flow Range		Inlet Sizes	Outlet Sizes
			gpm	L/hr		
PRLG10	10 psi (0.69 bar)	90 psi (6.20 bar)	0.5 - 7	114 - 1590	3/4" F hose, 3/4" F NPT	3/4" M hose, 3/4" M NPT
PRLG15	15 psi (1.03 bar)	95 psi (6.55 bar)	0.5 - 7	114 - 1590	3/4" F hose, 3/4" F NPT	3/4" M hose, 3/4" M NPT
PRLG20	20 psi (1.38 bar)	100 psi (6.89 bar)	0.5 - 7	114 - 1590	3/4" F hose, 3/4" F NPT	3/4" M hose, 3/4" M NPT
PRLG25	25 psi (1.72 bar)	105 psi (7.24 bar)	0.5 - 7	114 - 1590	3/4" F hose, 3/4" F NPT	3/4" M hose, 3/4" M NPT
PRLG30	30 psi (2.07 bar)	110 psi (7.58 bar)	0.5 - 7	114 - 1590	3/4" F hose, 3/4" F NPT	3/4" M hose, 3/4" M NPT
PRLG35	35 psi (2.41 bar)	115 psi (7.93 bar)	0.5 - 7	114 - 1590	3/4" F hose, 3/4" F NPT	3/4" M hose, 3/4" M NPT
PRLG40	40 psi (2.76 bar)	120 psi (8.27 bar)	0.5 - 7	114 - 1590	3/4" F hose, 3/4" F NPT	3/4" M hose, 3/4" M NPT

The pressure regulator shall maintain the predetermined operating pressure provided that the inlet pressure is at least 5 psi (0.34 bar) above the expected outlet pressure, but not exceeding the maximum inlet pressure as shown above.

CAUTION: Always install downstream from all shut-off valves. Recommended for outdoor use only. Not NSF certified.

PRL

The PRL (Pressure Regulator Low Flow) is ideal for installations requiring lower flows of 0.5 to 8.0 gpm (114 to 1817 L/hr). Suggested use is in solid-set, drip, or other low-volume irrigation systems.

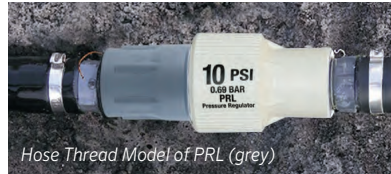

FEATURES

- Senninger® regulators maintain a constant preset outlet pressure with varying inlet pressures, which alleviates pressure differences that can cause an applicator's area of coverage to change.
- Pressure tested, to ensure quality and performance
- Very low hysteresis and friction losses
- Can be installed above or below ground
- Patented tamper-proof design
- No external metal parts for excellent corrosion resistance

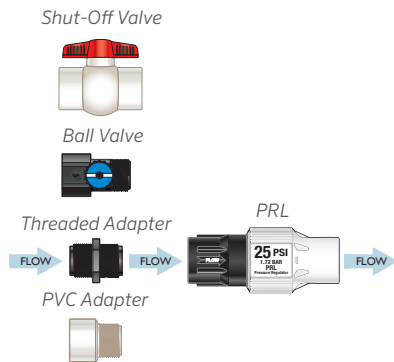

PRL DESIGN CRITERIA	Preset Outlet Pressure	Maximum Inlet Pressure	Flow Range		Inlet Sizes	Outlet Sizes
			gpm	L/hr		
PRL 06	6 psi (0.41 bar)	80 psi (5.51 bar)	0.5 - 5	114 - 1136	3/4" F NPT, 3/4" F hose	3/4" F NPT
PRL 10	10 psi (0.69 bar)	90 psi (6.20 bar)	0.5 - 8	114 - 1817	3/4" F NPT, 3/4" F hose	3/4" F NPT
PRL 12	12 psi (0.83 bar)	90 psi (6.20 bar)	0.5 - 8	114 - 1817	3/4" F NPT, 3/4" F hose	3/4" F NPT
PRL 15	15 psi (1.03 bar)	95 psi (6.55 bar)	0.5 - 8	114 - 1817	3/4" F NPT, 3/4" F hose	3/4" F NPT
PRL 20	20 psi (1.38 bar)	100 psi (6.89 bar)	0.5 - 8	114 - 1817	3/4" F NPT, 3/4" F hose	3/4" F NPT
PRL 25	25 psi (1.72 bar)	105 psi (7.24 bar)	0.5 - 8	114 - 1817	3/4" F NPT, 3/4" F hose	3/4" F NPT
PRL 30	30 psi (2.07 bar)	110 psi (7.58 bar)	0.5 - 8	114 - 1817	3/4" F NPT, 3/4" F hose	3/4" F NPT
PRL 35	35 psi (2.41 bar)	115 psi (7.93 bar)	0.5 - 8	114 - 1817	3/4" F NPT, 3/4" F hose	3/4" F NPT
PRL 40	40 psi (2.76 bar)	120 psi (8.27 bar)	0.5 - 8	114 - 1817	3/4" F NPT, 3/4" F hose	3/4" F NPT

The pressure regulator shall maintain the predetermined operating pressure provided that the inlet pressure is at least 5 psi (0.34 bar) above the expected outlet pressure, but not exceeding the maximum inlet pressure as shown above.

CAUTION: Always install downstream from all shut-off valves. Recommended for outdoor use only. Not NSF certified.

The Senninger® PSR™2 is designed to handle flows from 0.5 to 15.0 gpm (114 to 3407 L/hr). The patented design is ideal for use with surface water.

FEATURES

- Senninger regulators maintain a constant preset outlet pressure with varying inlet pressures, which alleviates pressure differences that can cause an applicator’s area of coverage to change.
- Pressure tested, to ensure quality and performance
- Very low hysteresis and friction loss
- Can be installed above or below ground



DESIGN PRESSURE	Pressure Variations			
	1 psi (0.069 bar)	2 psi (0.138 bar)	3 psi (0.207 bar)	5 psi (0.276 bar)
6 psi (0.41 bar)	8.3%	16.7%	25.0%	41.7%
10 psi (0.69 bar)	5.0%	10.0%	15.0%	25.0%
15 psi (1.03 bar)	3.3%	6.7%	10.0%	16.7%
20 psi (1.38 bar)	2.5%	5.0%	7.5%	12.5%
% Flow Variation				

Pressure regulators are recommended if there is a 10% pressure and/or a 5% flow variation. The lower a system’s design pressure, the more critical it is to accurately control its pressure.

PSR2 DESIGN CRITERIA	Preset Outlet Pressure	Maximum Inlet Pressure	Flow Range		Inlet Sizes	Outlet Sizes
			gpm	L/hr		
PSR2 06	6 psi (0.41 bar)	80 psi (5.51 bar)	0.5 - 15	114 - 3407	3/4" F NPT	3/4" F NPT
PSR2 10	10 psi (0.69 bar)	90 psi (6.20 bar)	0.5 - 15	114 - 3407	3/4" F NPT	3/4" F NPT
PSR2 12	12 psi (0.83 bar)	90 psi (6.20 bar)	0.5 - 15	114 - 3407	3/4" F NPT	3/4" F NPT
PSR2 15	15 psi (1.03 bar)	95 psi (6.55 bar)	0.5 - 15	114 - 3407	3/4" F NPT	3/4" F NPT
PSR2 20	20 psi (1.38 bar)	100 psi (6.89 bar)	0.5 - 15	114 - 3407	3/4" F NPT	3/4" F NPT
PSR2 25	25 psi (1.72 bar)	105 psi (7.24 bar)	0.5 - 15	114 - 3407	3/4" F NPT	3/4" F NPT
PSR2 30	30 psi (2.07 bar)	110 psi (7.58 bar)	0.5 - 15	114 - 3407	3/4" F NPT	3/4" F NPT
PSR2 35	35 psi (2.41 bar)	115 psi (7.93 bar)	0.5 - 15	114 - 3407	3/4" F NPT	3/4" F NPT
PSR2 40	40 psi (2.76 bar)	120 psi (8.27 bar)	0.5 - 15	114 - 3407	3/4" F NPT	3/4" F NPT
PSR2 50	50 psi (3.45 bar)	130 psi (8.96 bar)	0.5 - 15	114 - 3407	3/4" F NPT	3/4" F NPT

The pressure regulator shall maintain the predetermined operating pressure provided that the inlet pressure is at least 5 psi (0.34 bar) above the expected outlet pressure, but not exceeding the maximum inlet pressure as shown above.

CAUTION: Always install downstream from all shut-off valves. Recommended for outdoor use only. Not NSF certified.

Filter Regulator



The Senninger® Filter Regulator combines filtration and pressure regulation into one device for installation convenience. Combining PSR™2 performance with reduced nozzle clogging provides a solution for overall efficiency of an irrigation system.



FEATURES

- Senninger regulators maintain a constant preset outlet pressure with varying inlet pressures, which alleviates pressure differences that can cause an applicator’s area of coverage to change.
- Quality field proven PSR2 internal components
- Easy access to mesh screens with a twist of the bonnet; no tools required
- Convenient installation
- Pressure tested, to ensure quality and performance
- Can be installed above or below ground

Screen Models	Description	Screen Mesh Orifice (microns)
FPSR220SCREEN	Filter PSR2, 20 mesh screen, black rings	841
FPSR230SCREEN	Filter PSR2, 30 mesh screen, green rings	595
FPSR240SCREEN	Filter PSR2, 40 mesh screen, grey rings	400
FPSR2120SCREEN	Filter PSR2, 120 mesh screen, red rings	125
FPSR2140SCREEN	Filter PSR2, 140 mesh screen, blue rings	105



Shaded models designed for use with drip systems.

Color-coded stickers available for the outer bonnet to assist installers in matching the mesh size to the correct nozzle.

Easy in-field maintenance to exchange installed filter screens for new or cleaned screens. Clean screens for reinstallation during the next scheduled maintenance cycle.

Filter Regulator

FILTER REGULATOR DESIGN CRITERIA	Description	Mesh Orifice (microns)	Preset Outlet Pressure	Maximum Inlet Pressure	Flow Range
FPSR2063M3F20	6 psi, Filter PSR2, 3/4" M NPT x 3/4" F NPT, 20 mesh screen	841	6 psi (0.41 bar)	80 psi (5.51 bar)	0.5 - 15 gpm (114 - 3407 L/hr)
FPSR2063M3F30	6 psi, Filter PSR2, 3/4" M NPT x 3/4" F NPT, 30 mesh screen	595			
FPSR2063M3F40	6 psi, Filter PSR2, 3/4" M NPT x 3/4" F NPT, 40 mesh screen	400			
FPSR2103M3F20	10 psi, Filter PSR2, 3/4" M NPT x 3/4" F NPT, 20 mesh screen	841	10 psi (0.69 bar)	90 psi (6.20 bar)	0.5 - 15 gpm (114 - 3407 L/hr)
FPSR2103M3F30	10 psi, Filter PSR2, 3/4" M NPT x 3/4" F NPT, 30 mesh screen	595			
FPSR2103M3F40	10 psi, Filter PSR2, 3/4" M NPT x 3/4" F NPT, 40 mesh screen	400			
FPSR2153M3F20	15 psi, Filter PSR2, 3/4" M NPT x 3/4" F NPT, 20 mesh screen	841	15 psi (1.03 bar)	95 psi (6.55 bar)	0.5 - 15 gpm (114 - 3407 L/hr)
FPSR2153M3F30	15 psi, Filter PSR2, 3/4" M NPT x 3/4" F NPT, 30 mesh screen	595			
FPSR2153M3F40	15 psi, Filter PSR2, 3/4" M NPT x 3/4" F NPT, 40 mesh screen	400			
FPSR2203M3F20	20 psi, Filter PSR2, 3/4" M NPT x 3/4" F NPT, 20 mesh screen	841	20 psi (1.38 bar)	100 psi (6.89 bar)	0.5 - 15 gpm (114 - 3407 L/hr)
FPSR2203M3F30	20 psi, Filter PSR2, 3/4" M NPT x 3/4" F NPT, 30 mesh screen	595			
FPSR2203M3F40	20 psi, Filter PSR2, 3/4" M NPT x 3/4" F NPT, 40 mesh screen	400			
FPSR2103M3F120	10 psi, Filter PSR2, 3/4" M NPT x 3/4" F NPT, 120 mesh screen	125	10 psi (0.69 bar)	90 psi (6.20 bar)	0.5 - 15 gpm (114 - 3407 L/hr)
FPSR2103M3F140	10 psi, Filter PSR2, 3/4" M NPT x 3/4" F NPT, 140 mesh screen	105			
FPSR2153M3F120	15 psi, Filter PSR2, 3/4" M NPT x 3/4" F NPT, 120 mesh screen	125	15 psi (1.03 bar)	95 psi (6.55 bar)	0.5 - 15 gpm (114 - 3407 L/hr)
FPSR2153M3F140	15 psi, Filter PSR2, 3/4" M NPT x 3/4" F NPT, 140 mesh screen	105			
FPSR2203M3F120	20 psi, Filter PSR2, 3/4" M NPT x 3/4" F NPT, 120 mesh screen	125	20 psi (1.38 bar)	100 psi (6.89 bar)	0.5 - 15 gpm (114 - 3407 L/hr)
FPSR2203M3F140	20 psi, Filter PSR2, 3/4" M NPT x 3/4" F NPT, 140 mesh screen	105			

Shaded models designed for use with drip systems.

The pressure regulator shall maintain the predetermined operating pressure provided that the inlet pressure is at least 5 psi (0.34 bar) above the expected outlet pressure, with flows up to 11 gpm (2498 L/hr), but not exceeding the maximum inlet pressure as shown above. Higher flows require additional inlet pressure to engage the regulator. Where flows are greater than 11 gpm (2498 L/hr), the inlet pressure should be at least 9 psi (0.62 bar) above the expected outlet pressure but not exceeding the maximum inlet pressure as shown above.

Pressure regulators should always be installed downstream of all shut-off valves.

Recommended for outdoor use only. Not NSF certified.

PMR-MF

The PMR-MF (Pressure-Master Regulator™ Medium-Flow) is ideal for installations requiring mid-range flows of 2 to 20 gpm (454 to 4542 L/hr), including solid-set, drip and other low-volume irrigation systems.



FEATURES

- Senninger® regulators maintain a constant preset outlet pressure with varying inlet pressures, which alleviates pressure differences that can cause an applicator's area of coverage to change.
- Pressure tested, to ensure quality and performance
- Very low hysteresis and friction losses
- Can be installed above or below ground

OTHER MODELS AVAILABLE

PMR-MF EFF

(lavender top)
Designed specifically for wastewater applications.

PMR-MF CMS

Designed specifically for mining applications where pH solutions are less than or equal to 4.0.

BSPT

Designed with a 55° degree internal angle to fit these specific connections.

PMR-MF DESIGN CRITERIA	Preset Outlet Pressure	Maximum Inlet Pressure	Flow Range		Inlet Sizes	Outlet Sizes
			gpm	L/hr		
PMR06 MF	6 psi (0.41 bar)	80 psi (5.51 bar)	4 - 16	909 - 3634	¾" F NPT, 1" F NPT, 1" F BSPT	¾" F NPT, 1" F NPT, 1" F BSPT
PMR10 MF	10 psi (0.69 bar)	90 psi (6.20 bar)	4 - 16	909 - 3634	¾" F NPT, 1" F NPT, 1" F BSPT	¾" F NPT, 1" F NPT, 1" F BSPT
PMR12 MF	12 psi (0.83 bar)	90 psi (6.20 bar)	2 - 20	454 - 4542	¾" F NPT, 1" F NPT, 1" F BSPT	¾" F NPT, 1" F NPT, 1" F BSPT
PMR15 MF	15 psi (1.03 bar)	95 psi (6.55 bar)	2 - 20	454 - 4542	¾" F NPT, 1" F NPT, 1" F BSPT	¾" F NPT, 1" F NPT, 1" F BSPT
PMR20 MF	20 psi (1.38 bar)	100 psi (6.89 bar)	2 - 20	454 - 4542	¾" F NPT, 1" F NPT, 1" F BSPT	¾" F NPT, 1" F NPT, 1" F BSPT
PMR25 MF	25 psi (1.72 bar)	105 psi (7.24 bar)	2 - 20	454 - 4542	¾" F NPT, 1" F NPT, 1" F BSPT	¾" F NPT, 1" F NPT, 1" F BSPT
PMR30 MF	30 psi (2.07 bar)	110 psi (7.58 bar)	2 - 20	454 - 4542	¾" F NPT, 1" F NPT, 1" F BSPT	¾" F NPT, 1" F NPT, 1" F BSPT
PMR35 MF	35 psi (2.41 bar)	115 psi (7.93 bar)	2 - 20	454 - 4542	¾" F NPT, 1" F NPT, 1" F BSPT	¾" F NPT, 1" F NPT, 1" F BSPT
PMR40 MF	40 psi (2.76 bar)	120 psi (8.27 bar)	2 - 20	454 - 4542	¾" F NPT, 1" F NPT, 1" F BSPT	¾" F NPT, 1" F NPT, 1" F BSPT
PMR50 MF	50 psi (3.45 bar)	130 psi (8.96 bar)	2 - 20	454 - 4542	¾" F NPT, 1" F NPT, 1" F BSPT	¾" F NPT, 1" F NPT, 1" F BSPT
PMR60 MF	60 psi (4.14 bar)	140 psi (9.65 bar)	2 - 20	454 - 4542	¾" F NPT, 1" F NPT, 1" F BSPT	¾" F NPT, 1" F NPT, 1" F BSPT

The pressure regulator shall maintain the predetermined operating pressure provided that the inlet pressure is at least 5 psi (0.34 bar) above the expected outlet pressure, but not exceeding the maximum inlet pressure as shown above.

CAUTION: Always install downstream from all shut-off valves. Recommended for outdoor use only. Not NSF certified.

PR-HF



The PR-HF (Pressure Regulator High Flow) is ideal for installations requiring higher flows of 10 to 32 gpm (2271 to 7268 L/hr), including solid-set sprinkler and low volume manifolds.

FEATURES

- Senninger® regulators maintain a constant preset outlet pressure with varying inlet pressures, which alleviates pressure differences that can cause an applicator’s area of coverage to change.
- Pressure tested, to ensure quality and performance
- Very low hysteresis and friction losses
- Can be installed above or below ground



PR-HF DESIGN CRITERIA	Preset Outlet Pressure	Maximum Inlet Pressure	Flow Range		Inlet Sizes	Outlet Sizes
			gpm	L/hr		
PR10 HF	10 psi (0.69 bar)	90 psi (6.20 bar)	10 - 32	2271 - 7268	1 ¼" F NPT, 1 ¼" F BSPT	1" F NPT, 1 ¼" F NPT, 1" F BSPT, 1 ¼" F BSPT
PR15 HF	15 psi (1.03 bar)	95 psi (6.55 bar)	10 - 32	2271 - 7268	1 ¼" F NPT, 1 ¼" F BSPT	1" F NPT, 1 ¼" F NPT, 1" F BSPT, 1 ¼" F BSPT
PR20 HF	20 psi (1.38 bar)	100 psi (6.89 bar)	10 - 32	2271 - 7268	1 ¼" F NPT, 1 ¼" F BSPT	1" F NPT, 1 ¼" F NPT, 1" F BSPT, 1 ¼" F BSPT
PR25 HF	25 psi (1.72 bar)	105 psi (7.24 bar)	10 - 32	2271 - 7268	1 ¼" F NPT, 1 ¼" F BSPT	1" F NPT, 1 ¼" F NPT, 1" F BSPT, 1 ¼" F BSPT
PR30 HF	30 psi (2.07 bar)	110 psi (7.58 bar)	10 - 32	2271 - 7268	1 ¼" F NPT, 1 ¼" F BSPT	1" F NPT, 1 ¼" F NPT, 1" F BSPT, 1 ¼" F BSPT
PR40 HF	40 psi (2.76 bar)	120 psi (8.27 bar)	10 - 32	2271 - 7268	1 ¼" F NPT, 1 ¼" F BSPT	1" F NPT, 1 ¼" F NPT, 1" F BSPT, 1 ¼" F BSPT
PR50 HF	50 psi (3.45 bar)	130 psi (8.96 bar)	10 - 32	2271 - 7268	1 ¼" F NPT, 1 ¼" F BSPT	1" F NPT, 1 ¼" F NPT, 1" F BSPT, 1 ¼" F BSPT

The pressure regulator shall maintain the predetermined operating pressure provided that the inlet pressure is at least 5 psi (0.34 bar) above the expected outlet pressure, but not exceeding the maximum inlet pressure as shown above.

CAUTION: Always install downstream from all shut-off valves. Recommended for outdoor use only. Not NSF certified.

PRU



The PRU (Pressure Regulator Ultra) was designed to handle higher flows of 20 to 100 gpm (4542 - 22713 L/hr). Its 2-inch inlet and outlet size make it an ideal option for accurate zone and individual sprinkler pressure control. Its compact size fits in a valve box.

FEATURES

- Senninger® regulators maintain a constant preset outlet pressure with varying inlet pressures, which alleviates pressure differences that can cause an applicator's area of coverage to change.
- Pressure tested, to ensure quality and performance
- Very low hysteresis and friction losses
- Can be installed above or below ground

ZONE AND SINGLE FLOW APPLICATIONS:

- Agricultural
- Nursery
- Effluent
- Landscape/Turf
- Golf Course/Sports Field
- Mining



PRU DESIGN CRITERIA	Preset Outlet Pressure	Maximum Inlet Pressure	Flow Range		Inlet Sizes	Outlet Sizes
			gpm	L/hr		
PRU 10	10 psi (0.69 bar)	90 psi (6.20 bar)	20 - 100	4542 - 22713	2" F NPT, 2" F BSPT	2" F NPT, 2" F BSPT
PRU 15	15 psi (1.03 bar)	95 psi (6.55 bar)	20 - 100	4542 - 22713	2" F NPT, 2" F BSPT	2" F NPT, 2" F BSPT
PRU 20	20 psi (1.38 bar)	100 psi (6.89 bar)	20 - 100	4542 - 22713	2" F NPT, 2" F BSPT	2" F NPT, 2" F BSPT
PRU 25	25 psi (1.72 bar)	105 psi (7.24 bar)	20 - 100	4542 - 22713	2" F NPT, 2" F BSPT	2" F NPT, 2" F BSPT
PRU 30	30 psi (2.07 bar)	110 psi (7.58 bar)	20 - 100	4542 - 22713	2" F NPT, 2" F BSPT	2" F NPT, 2" F BSPT
PRU 40	40 psi (2.76 bar)	120 psi (8.27 bar)	20 - 100	4542 - 22713	2" F NPT, 2" F BSPT	2" F NPT, 2" F BSPT
PRU 50	50 psi (3.45 bar)	130 psi (8.96 bar)	20 - 100	4542 - 22713	2" F NPT, 2" F BSPT	2" F NPT, 2" F BSPT
PRU 60	60 psi (4.14 bar)	140 psi (9.65 bar)	20 - 100	4542 - 22713	2" F NPT, 2" F BSPT	2" F NPT, 2" F BSPT

The pressure regulator shall maintain the predetermined operating pressure provided that the inlet pressure is at least 5 psi (0.34 bar) above the expected outlet pressure, but not exceeding the maximum inlet pressure as shown above.

CAUTION: Always install downstream from all shut-off valves. Recommended for outdoor use only. Not NSF certified.

The PRLV was designed to handle flows up to 18 gpm (4088 L/hr). Pressure Regulating Limit Valves are designed to be used in place of standard pressure regulators to limit static (no flow) water pressure when a shut-off valve is used downstream from the regulation point. This limits downstream pressure and protects downstream components.

FEATURES

- Limits downstream pressure to no more than 15 psi (1.03 bar) above regulated pressure rating during static (no flow) conditions
- Pressure tested, to ensure quality and performance
- Very low hysteresis and friction losses



PRLV RECOMMENDED INSTALLATION

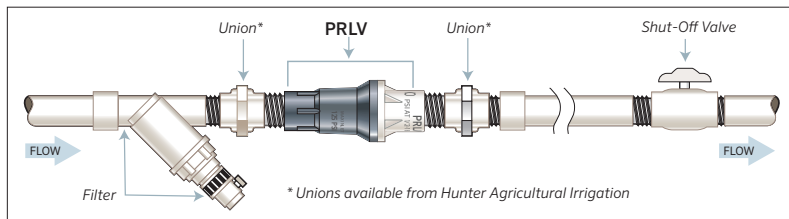

PRLV DESIGN CRITERIA	Preset Outlet Pressure	Maximum Inlet Pressure	Maximum Flow		Inlet Sizes	Outlet Sizes
			gpm	L/hr		
PRLV 10	10 psi (0.69 bar)	125 psi (8.62 bar)	18	4088	¾" F NPT, 1" F NPT	¾" F NPT, 1" F NPT
PRLV 15	15 psi (1.03 bar)	125 psi (8.62 bar)	18	4088	¾" F NPT, 1" F NPT	¾" F NPT, 1" F NPT
PRLV 20	20 psi (1.38 bar)	125 psi (8.62 bar)	18	4088	¾" F NPT, 1" F NPT	¾" F NPT, 1" F NPT
PRLV 30	30 psi (2.07 bar)	125 psi (8.62 bar)	18	4088	¾" F NPT, 1" F NPT	¾" F NPT, 1" F NPT
PRLV 40	40 psi (2.76 bar)	125 psi (8.62 bar)	18	4088	¾" F NPT, 1" F NPT	¾" F NPT, 1" F NPT
PRLV 50	50 psi (3.45 bar)	125 psi (8.62 bar)	18	4088	¾" F NPT, 1" F NPT	¾" F NPT, 1" F NPT
PRLV 60	60 psi (4.14 bar)	125 psi (8.62 bar)	18	4088	¾" F NPT, 1" F NPT	¾" F NPT, 1" F NPT

The PRLV limits downstream pressure to no more than 15 psi (1.03 bar) above regulated pressure during static (no flow) conditions..

Recommended for outdoor use only. Not NSF certified.

PRXF-LV



The PRXF-LV was designed to handle flows up to 75 gpm (17034 L/hr). Pressure Regulating Limit Valves are designed to be used in place of standard pressure regulators to limit static (no flow) water pressure when a shut-off valve is used downstream from the regulation point. This limits downstream pressure and protects downstream components.

FEATURES

- Limits downstream pressure to no more than 15 psi (1.03 bar) above regulated pressure rating during static (no flow) conditions
- Pressure tested, to ensure quality and performance
- Very low hysteresis and friction losses



PRXF-LV DESIGN CRITERIA

	Preset Outlet Pressure	Maximum Inlet Pressure	Maximum Flow		Inlet Sizes	Outlet Sizes
			gpm	L/hr		
PRXF 20 LV	20 psi (1.38 bar)	125 psi (8.62 bar)	75	17034	3" F slip	3" F slip
PRXF 30 LV	30 psi (2.07 bar)	125 psi (8.62 bar)	75	17034	3" F slip	3" F slip
PRXF 40 LV	40 psi (2.76 bar)	125 psi (8.62 bar)	75	17034	3" F slip	3" F slip
PRXF 50 LV	50 psi (3.45 bar)	125 psi (8.62 bar)	75	17034	3" F slip	3" F slip
PRXF 60 LV	60 psi (4.14 bar)	125 psi (8.62 bar)	75	17034	3" F slip	3" F slip

The PRXF-LV limits downstream pressure to no more than 15 psi (1.03 bar) above regulated pressure during static (no flow) conditions.

Recommended for outdoor use only. Not NSF certified.

INSTALLATION GUIDELINES

- Never allow solvent or cement to drip into regulator.
- Make sure the flow arrows on the regulator match the direction of the system flow.
- Installation of a union is recommended for easy removal of PRXF-LV.

Irrimaker

Irrimaker and IrriExpress let you design comprehensive irrigation projects ranging from large-scale agricultural designs to small-scale landscape designs. Both programs let users evaluate installation alternatives in advance, survey any terrain, produce a contour plan, draw the details, and apply the irrigation design.

FEATURES

- All in one software package: combines surveyed data, CAD, Digital Terrain Modeling (DTM) and irrigation calculation functions
- Generates contour plans and 3D images illustrating the irrigation design in relation to slopes and elevations
- Calculate hydraulics, pressures, flows and quantities
- Full graphical control over each element of the design, including block areas, sprinklers, and pipes
- Saves time on repeatable routines
- Allows importation of information from many other programs

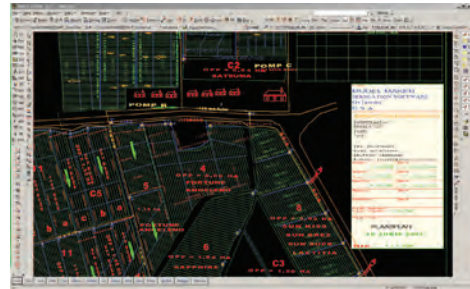

CAD enhanced drawings let you plot specific terrain details that can impact an installation.

IRRIMAKER can be used for everything from simple irrigation designs to complex systems and provides full control over irrigation system design. Its built-in CAD module lets you add specific details to the contour plan like roads, fences, boundaries, rivers, and trees, including text and bitmap images. Irrimaker also operates within the larger Model Maker environment. This means any of the other Model Maker modules can be added to your software package.

CALL FOR INFORMATION ON
PURCHASING THIS PROGRAM

IrriExpress

YOU CAN LEARN MORE ABOUT
IRRIEXPRESS AND EVEN
DOWNLOAD A DEMO ONLINE
AT WWW.IRRIEXPRESS.COM

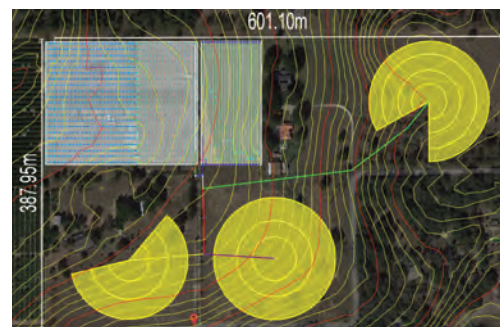

IRRIEXPRESS is a lighter version of Irrimaker that is simple enough for beginners yet powerful enough for experts. It seamlessly imports topography data from Google Maps and lets you design over your defined area's elevation points. It includes a familiar user interface and highly intuitive features like copy and paste and undo and redo, which help you navigate through the program with ease.

WinSIPP™3

Use WinSIPP™3 software by Senninger® to calculate the precipitation rate of your irrigation system.

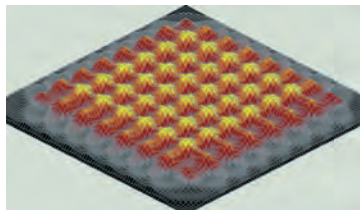

Graphics illustrate the water application pattern in 3-D format.

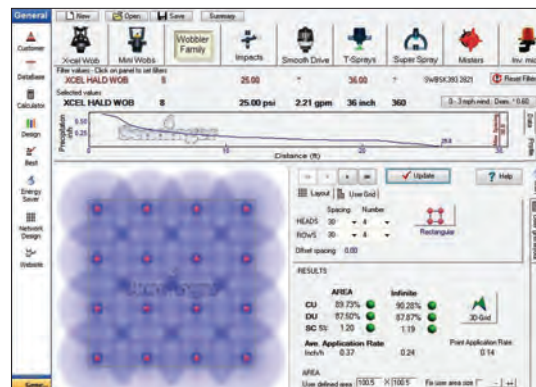

Densograms illustrate the uniformity, wetted diameter, and application pattern of a given profile.

FEATURES

- Aids in the selection of the best irrigation products for each particular soil and installation type.
- Tests the application uniformity of sprinkler layouts before the system is installed
- Compares different spacings, sprinkler models, nozzle sizes, and operating pressures to determine which would be best for your specific application.
- Sprinkler profile uses specific data and illustrates the amount of water that would be delivered at various intervals, the application radius, and the water distribution of multiple overlapping devices.

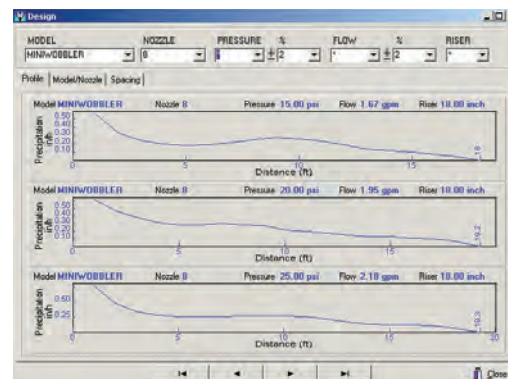

Sprinkler profiles illustrate the amount of water that would be delivered at various intervals as well as the radius of throw.

DISTRIBUTION PROFILE

A distribution profile is the illustration of the results from "catch can" tests performed in accordance with the American Society of Agricultural and Biological Engineers (ASABE) standard S398.1. This data shows how uniformly a device distributes water within its diameter of throw. WinSIPP3 utilizes the numerous distribution profiles available for Senninger products.

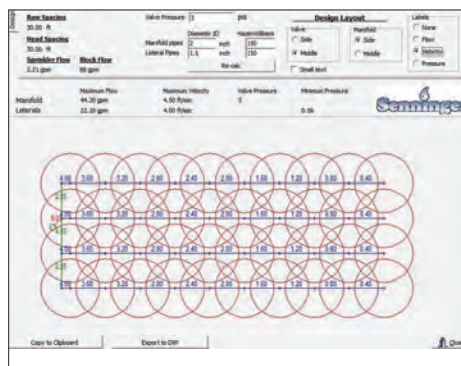

Layout calculator renders sprinkler system designs and provides specifics on flow, velocity and pressures along manifolds in lateral lines.

DENSOGRAM

Data from distribution profiles is used to create densograms based on spacing dimensions, layout, and riser height. Densograms are useful in illustrating the uniformity of water distribution by multiple overlapping devices.

THIS FREE PROGRAM IS AVAILABLE ONLINE AT SENNINGER.COM/DOWNLOAD/WINSIPP3

Formulas & Conversions

INSIDE DIAMETERS- FOR PVC (IPSMM)

Size (inches)	125 (SDR-32.5)		160 (SDR-26)		200 (SDR-21)	
	inches	mm	inches	mm	inches	mm
¾	---	---	---	---	0.950	24.13
1	---	---	1.195	30.35	1.190	30.22
1¼	---	---	1.532	38.91	1.502	38.15
1½	1.783	45.29	1.754	44.55	1.719	43.66
2	2.229	56.61	2.193	55.70	2.149	54.58
2½	2.698	68.53	2.655	67.44	2.601	66.07
3	3.284	83.41	3.230	82.04	3.166	80.42
4	4.224	107.29	4.154	105.51	4.072	103.43
6	6.217	157.91	6.115	155.32	5.993	152.22
8	8.095	205.61	7.961	202.21	7.805	198.25
10	10.088	256.23	9.924	252.07	9.726	247.05
12	11.966	303.93	11.770	298.95	11.536	293.01

Regulated pressure is 1/2 psi (0.03 bar) higher with increasing inlet pressure than with decreasing inlet pressure

CALCULATING FRICTION LOSS OF PIPE- (Hazen-Williams)

$H_f = 1045 \frac{(GPM \pm C)^{1.852}}{ID^{4.857}}$	$H_f = 1.22 \times 10^{12} \frac{(LPS \pm C)^{1.852}}{ID^{4.857}}$
Hf = Friction Loss in Feet of Water (head) per 100 Feet of Pipe	Hf = Friction Loss in Meters of Water (head) per 100 Meters of Pipe
GPM = Flow (gal/minute)	LPS = Flow (liters/second)
C = Pipe Coefficient (PVC = 150, Aluminum w/couplers =120, Galv.Steel/Asb. - Cement = 140 or Cast Iron = 100)	C = Pipe Coefficient (PVC = 150, Aluminum w/couplers =120, Galv.Steel/Asb. -Cement = 140 or Cast Iron = 100)
ID = Pipe Inside Diameter (inches)	ID = Pipe Inside Diameter (mm)

ESTIMATING SYSTEM PUMPING REQUIREMENTS

$GPM = \frac{IN \times Acres \times 452.6}{Days \times HRS \times EFF}$	$LPS = \frac{CM \times HA \times 27.8}{Days \times HRS \times EFF}$
IN= Net application depth per irrigation event (inches)*	CM= Net application depth (centimeters)
Acres= Area to be irrigated (acres)	HA= Area to be irrigated (hectares)
Days= Number of irrigation days	Days= Number of irrigation days
HRS= Number of irrigation hrs per/day	HRS= Number of irrigation hrs per/day
EFF= System efficiency (see table below)	EFF= System efficiency (see table below)

ESTIMATING BRAKE POWER REQUIRED

$BP = \frac{GPM \times TDH}{3960 \times EFF}$	$BP = \frac{LPS \times TDH}{120 \times EFF}$
BP= Brake Power required (horse power)	BP= Brake Power required (kilo)
GPM= Flow required (gal/minute)	LPS= Flow required (liters/second)
TDH= Total dynamic head (in ft)	TDH= Total dynamic head (in meters)
EFF= Pump efficiency stated as a decimal	EFF= Pump efficiency stated as a decimal

FLOW CONVERSION

TO CONVERT	INTO	MULTIPLY BY
Acre-Inch/hr	Gallons/Min (gpm)	452.6
Acre-Inch/hr	Gallons/hr	27.154
Cubic Feet/hr	Gallons/hr (US)	7.481
Cubic Feet/Sec	Gallons/Min (gpm)	448.831
Cubic Meters/hr	Gallons/hr (US)	264.2
Cubic Meters/hr	Gallons/Min (gpm)	4.403
Cubic Meters/hr	Liters/Sec (L/s)	0.278
Gallons/hr	Liters/hr	3.785
Gallons/Min. (gpm)	Cubic Meter/hr (m ³ /hr)	0.227
Gallons/Min. (gpm)	Liters/Sec (L/s)	0.063
Liters/hr	Gallons/hr (US)	0.264
Liters/Second	Gallons/Min (gpm)	15.85
Liters/Second	Cubic Meters/hr (m ³ /hr)	3.600

PRESSURE CONVERSION

TO CONVERT	INTO	MULTIPLY BY
Atmospheres	Kilograms/Sq. Cm	1.033
Atmospheres	Pounds/Sq. In. (psi)	14.70
Bar	Pounds/Sq. In. (psi)	14.50
Feet Head (of Water)	Pounds/Sq. In. (psi)	0.433
Gallons of Water	Pounds	8.33
Kilograms/Sq. Cm	Pounds/Sq. In. (psi)	14.22
Kilopascals (kPa)	Pounds/Sq. In. (psi)	0.145
Pounds/Sq. In. (psi)	Atmospheres	0.068
Pounds/Sq. In. (psi)	Bar	0.069
Pounds/Sq. In. (psi)	Feet Head (of Water)	2.307
Pounds/Sq. In. (psi)	Kilopascals (kPa)	6.895

AREA & LINEAR CONVERSION

TO CONVERT	INTO	MULTIPLY BY
Acres	Hectares	0.405
Acres	Square Feet	43.560
Centimeters	Inches	0.394
Feet	Meters	0.305
Hectares	Acres	2.471
Inches	Millimeters	25.40
Meters	Feet	3.281
Miles	Kilometers	1.609
Miles	Feet	5.280
Millimeters	Inches	0.0394

POWER CONVERSION

TO CONVERT	INTO	MULTIPLY BY
Horsepower	Kilowatts	0.746
Kilowatts	Horsepower	1.341

ESTIMATING IRRIGATION SYSTEMS EFFICIENCIES

Arid Regions	65%
Semi-Arid Regions	70%
Semi-Humid Regions	75%
Humid Regions	80%

millimeters per hour **Metric Rates**

Spacing Meters	Flow (m ³ /hr)																				
	0.07	0.11	0.18	0.36	0.56	0.72	0.90	1.08	1.44	1.80	2.16	2.52	2.88	3.24	3.60	3.96	4.32	5.40	6.40	7.20	
1.5 x 1.5	32.0	48.0	80.0	160.0	240.0	320.0															
2 x 2	18.0	27.0	45.0	90.0	135.0	180.0															
2.5 x 2.5	11.5	17.3	28.8	57.6	86.4	115.2	144.0														
3 x 3	8.0	12.0	20.0	40.0	60.0	80.0	100.0	120.0	160.0												
3.5 x 3.5	5.9	8.8	14.7	29.4	44.1	58.8	73.5	88.2	117.6	146.9	176.3										
4 x 4	4.5	6.8	11.3	22.5	33.8	45.0	56.3	67.5	90.0	112.5	135.0										
5 x 5	2.9	4.3	7.2	14.4	21.6	28.8	36.0	43.2	57.6	72.0	86.4										
6 x 6	2.0	3.0	5.0	10.0	15.0	20.0	25.0	30.0	40.0	50.0	60.0										
6 x 9			3.3	6.6	10.0	13.3	16.6	20.0	26.6	33.3	40.0	46.6	53.0								
6 x 12			2.5	5.0	7.5	10.0	12.5	15.0	20.0	25.0	30.0	35.0	40.0	45.0	50.0						
8 x 8			2.8	5.6	8.4	11.2	14.0	16.9	22.5	28.1	33.7	39.4	45.0	50.0							
9 x 9			2.2	4.4	6.6	8.9	11.1	13.3	17.8	22.2	26.6	31.1	35.5	40.0	44.4	48.8	53.3				
9 x 12			1.6	3.3	5.0	6.6	8.3	10.0	13.3	16.6	20.0	23.3	26.6	30.0	33.3	36.6	40.0	50.0	59.2		
9 x 14			1.4	2.8	4.3	5.7	7.1	8.6	11.4	14.3	17.1	20.0	22.8	25.7	28.5	31.4	34.3	42.8	50.8		
9 x 15			1.3	2.7	4.0	5.3	6.6	8.0	10.6	13.3	16.0	18.6	21.3	24.0	26.6	29.4	32.0	40.0	47.4		
9 x 18				2.2	3.3	4.4	5.5	6.6	8.9	11.1	13.3	15.5	17.8	20.0	22.2	24.4	26.6	33.3	39.5	44.4	
12 x 12				2.5	3.7	5.0	6.2	7.5	10.0	12.5	15.0	17.5	20.0	22.5	25.0	27.5	30.0	37.5	44.4	50.0	
12 x 15				2.0	3.0	4.0	5.0	6.0	8.0	10.0	12.0	14.0	16.0	18.0	20.0	22.0	24.0	30.0	35.5	40.0	
12 x 18				1.6	2.5	3.3	4.2	5.0	6.6	8.3	10.0	11.6	13.3	15.0	16.6	18.3	20.0	25.0	29.6	33.3	
15 x 15						3.2	4.0	4.8	6.4	8.0	9.6	11.2	12.8	14.4	16.0	17.6	19.2	24.0	28.4	32.0	
15 x 18						2.6	3.3	4.0	5.3	6.6	8.0	9.3	10.6	12.0	13.3	14.6	16.0	20.0	23.7	26.6	
15 x 21						2.3	2.8	3.4	4.6	5.7	6.8	8.0	9.1	10.3	11.4	12.6	13.7	17.1	20.3	22.8	
18 x 18								3.3	4.4	5.5	6.6	7.8	8.9	10.0	11.1	12.2	13.3	16.6	20.0	22.2	
18 x 21	Product	Pattern Spacing*						2.8	3.8	4.7	5.7	6.6	7.6	8.6	9.5	10.5	11.4	14.3	16.9	19.0	
18 x 24	T-Spray™	up to 2.0 meters						2.5	3.3	4.2	5.0	5.8	6.6	7.5	8.3	9.1	10.0	12.5	14.8	16.6	
21 x 21	Super Spray®	up to 3.5 meters						2.4	3.2	4.1	4.9	5.7	6.5	7.3	8.1	8.9	9.8	12.2	14.5	16.3	
21 x 24	Xcel-Wobbler™ HA	up to 9.2 meters							2.8	3.6	4.3	5.0	5.7	6.4	7.1	7.8	8.6	10.7	12.7	14.3	
21 x 27	Xcel-Wobbler™ MA	up to 7.5 meters							2.5	3.2	3.8	4.4	5.1	5.7	6.3	7.0	7.6	9.5	11.3	12.7	
24 x 24	Wobbler® SA	up to 9.2 meters								3.1	3.7	4.3	5.0	5.6	6.2	6.9	7.5	9.4	11.1	12.5	
24 x 30	Wobbler® LA	up to 7.5 meters								2.5	3.0	3.5	4.0	4.5	5.0	5.5	6.0	7.5	8.9	10.0	
28 x 33	mini-Wobbler™	up to 6.0 meters									2.3	2.7	3.1	3.5	3.9	4.3	4.7	5.8	6.9	7.8	
30 x 30	i-mini-Wobbler™	up to 3.5 meters									2.4	2.8	3.2	3.9	4.0	4.4	4.8	6.0	7.1	8.0	
	Smooth Drive™ HA	up to 12.2 meters																			
	Smooth Drive™ LA	up to 11.3 meters																			
	20 Series Impact	up to 12.0 meters																			
	30 Series Impact	up to 18.5 meters																			
	40 Series Impact	up to 20.0 meters																			
	50 Series Impact	up to 21.5 meters																			
	70 Series Impact	up to 27.5 meters																			
	80 Series Impact	up to 30.5 meters																			

* Distance between sprinklers and rows in square or triangular patterns.

MAXIMUM PRECIPITATION RATES FOR LEVEL GROUND

Soil	Rate
Coarse Sands	19.0 - 25.4 mm/hr
Fine Sands	12.7 - 19.0 mm/hr
Fine Sandy Loams	8.9 - 12.7 mm/hr
Silt Loams	6.3 - 10.2 mm/hr
Clay Loams	2.5 - 7.6 mm/hr

KEY

m³/hr = flow per sprinkler

S = spacing of sprinklers along the lateral (in meters)

L = spacing between laterals (in meters)

(This applies to square, rectangular, or triangular spacing)

PRECIPITATION RATE FORMULA

$$\text{Application Rate} = \frac{\text{m}^3/\text{hr} \times 1000}{S \times L}$$

(mm per hour)

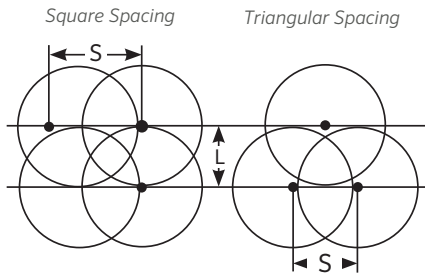

Nozzles

Hand-Tight Nozzles™ combine the nozzle and vane for impact sprinklers. It eliminates the need for tools during nozzle cleaning or changing. The nozzle and vane combination is simply placed inside the barrel of a Senninger® impact sprinkler and installed with a few quick turns. This new concept eliminates the possibility of losing a vane or nozzle retainer and simplifies renozzling.



FEATURES

- Saves time
- Square orifice nozzles also available for better stream break-up and improved uniformity
- Includes stream-straightening vane for maximum throw distance over a wide range of pressures
- Half size nozzles are easily identified by a colored insert.

One piece nozzle replaces the 3-part nozzle assembly for quick and easy in-field renozzling.



IMPACTS	MINIMUM	MAXIMUM
	Nozzle Size	Nozzle Size
20 Series Impacts	#6 Nozzle - Gold 3/32" (2.38 mm)	#9 Nozzle - Grey 9/64" (3.57 mm)
Compact Impact	#9 Nozzle - Grey 9/64" (3.57 mm)	#12 Nozzle - Red 3/16" (4.76 mm)
WedgeDrive™	#5 Nozzle - Beige 5/64" (1.98 mm)	#9 Nozzle - Grey 9/64" (3.57 mm)
30 Series Impacts (including Part-Circle 3123)	#7 Nozzle - Lime 7/64" (2.78 mm)	#10 Nozzle - Turquoise 5/32" (3.97 mm)
40 Series Impacts (including Part-Circle 4123)	#10 Nozzle - Turquoise 5/32" (3.97 mm)	#14 Nozzle - Blue 7/32" (5.56 mm)
50 Series Impacts (including Part-Circle 5123)	#13 Nozzle - White 13/64" (5.16 mm)	#18 Nozzle - Purple 9/32" (7.14 mm)

ORIFICE DIAMETER

#4 Light Blue	1/16 (0.063) inch	(1.59 mm)
#5 Beige	5/64 (0.078) inch	(1.98 mm)
#6 Gold	3/32 (0.094) inch	(2.38 mm)
#7 Lime	7/64 (0.109) inch	(2.78 mm)
#8 Lavender	1/8 (0.125) inch	(3.18 mm)
#9 Grey	9/64 (0.141) inch	(3.57 mm)
#10 Turquoise	5/32 (0.156) inch	(3.97 mm)
#11 Yellow	11/64 (0.172) inch	(4.37 mm)
#12 Red	3/16 (0.188) inch	(4.76 mm)
#13 White	13/64 (0.203) inch	(5.16 mm)
#14 Blue	7/32 (0.219) inch	(5.56 mm)
#15 Dk. Brown	15/64 (0.234) inch	(5.95 mm)
#16 Orange	1/4 (0.250) inch	(6.35 mm)
#17 Dk. Green	17/64 (0.266) inch	(6.75 mm)
#18 Purple	9/32 (0.281) inch	(7.14 mm)
#19 Black	19/64 (0.297) inch	(7.54 mm)
#20 Dk. Turquoise	5/16 (0.313) inch	(7.94 mm)
#21 Mustard	21/64 (0.328) inch	(8.33 mm)
#22 Maroon	11/32 (0.344) inch	(8.73 mm)
#23 Cream	23/64 (0.359) inch	(9.13 mm)
#24 Dk. Blue	3/8 (0.375) inch	(9.53 mm)
#25 Copper	25/64 (0.391) inch	(9.92 mm)
#26 Bronze	13/32 (0.406) inch	(10.32 mm)

Half sizes (128th inch increments) are also available in some models.

FEATURES

- Color-coded for easy size identification
- Excellent durability
- Warranted to maintain correct orifice size for five years

Product Warranty

WARRANTY & DISCLAIMER

This warranty supersedes all other warranties expressed or implied.

No person has the authority to incur or assume for Hunter Agriculture Incorporated (“Hunter Agriculture”) any other liability as to Hunter Agriculture Incorporated.

This warranty does not extend to any product or part that has been repaired, altered, or modified in any way outside the Hunter Agriculture factory, nor shall it apply to any product that has been subject to misuse, negligence, accident, or improper operation contrary to the Hunter Agriculture published instructions.

Under no circumstances will Hunter Agriculture be held responsible or liable for any consequential, incidental, or punitive damages resulting from the use of Senninger® products or from any product defects, failures, or malfunctions.

This warranty applies only to the original purchaser of the Senninger product and does not extend to any product or part manufactured by others.

MATERIALS AND WORKMANSHIP

Senninger products manufactured by Hunter Agriculture Incorporated for use in agriculture, turf, or nursery applications are warranted to be free of defects in materials or workmanship under normal use for a period of two (2) years from the date of manufacture.

Hunter Agriculture warrants the Senninger i-Wob®2 to be free of defects in materials or workmanship under normal use for a period of three (3) years from the date of manufacture.

Hunter Agriculture warrants the following products to be free of defects in materials or workmanship under normal use for a period of one (1) year from the date of manufacture: End Spray, PRLV regulators, and mining models.

Hunter Agriculture warrants nozzles to retain their original orifice size under normal use for a period of five (5) years from the date of manufacture.

PERFORMANCE

Senninger products manufactured by Hunter Agriculture Incorporated for use in agriculture, turf, or nursery applications are warranted to maintain their original performance for a period of two (2) years from the date of manufacture if installed and operated in accordance with Hunter Agriculture’s published specifications and used as intended for irrigation purposes.

Hunter Agriculture warrants the Senninger i-Wob®2 to maintain its original performance under normal use for a period of three (3) years from the date of manufacture.

Hunter Agriculture warrants the following products to maintain their original performance under normal use for a period of one (1) year from the date of manufacture: End Spray, PRLV regulators, and mining models.

REPAIR OR REPLACEMENT

If a Senninger product is suspected of failure during the applicable warranty period, Hunter Agriculture Incorporated will repair or replace the product or the defective part at its option. Contact Hunter Agriculture customer service in Clermont, Florida, USA, for specific instructions on how to proceed with a warranty claim. If, after inspection of the product and documentation, the failure is deemed a warranty issue, a replacement or credit will be authorized.

Hunter Agriculture is not obligated to pay for repairs or replacements made by anyone else. No labor allowances will be made for the removal or replacement of warranted parts or for travel to and from the product to make said repairs or replacements without prior written authorization from Hunter Agriculture.

SUITABILITY

There are no other warranties, expressed or implied, including warranties of merchantability and fitness for a particular purpose. It is the sole responsibility of the purchaser to consider and analyze the product and its design to determine whether it is suitable for specific applications.

Hunter® | *Agricultural Irrigation*

At Hunter Agricultural Irrigation, our commitment is to continue developing world-class Senninger® irrigation products and providing local support and technical expertise. This results in the most efficient and reliable agricultural irrigation solutions available today.



Steve Abernethy, President of Hunter Agricultural Irrigation

Website hunterirrigation.com/agriculture | **Customer Support** +1-407-877-5655

Domestic Customer Service us-cs@hunter.global | **International Customer Service** intl-cs@hunter.global

FLORIDA HEADQUARTERS

1963 Healy Way
Clermont, FL 34711 USA
Tel: +1-407-877-5655

NEBRASKA WAREHOUSE

1713 Holland Drive
Grand Island, NE 68803 USA
Tel: +1-308-381-8558

TEXAS WAREHOUSE

5810 50th Street
Lubbock, TX 79424 USA
Tel: +1-806-793-3010

BRAZIL

Praça Emilio Marconato
1000 Galpão G-44
Núcleo Residencial Doutor João Aldo Nassif
Jaguariúna - SP CEP 13916-074
Tel: +55-19-3802-1917

© 2025 Hunter Industries Inc., Hunter, the Hunter logo, Senninger, and other marks are trademarks of Hunter Industries Inc., registered in the U.S. and certain other countries. Please recycle.